

SPLIT-TYPE AIR CONDITIONERS

Changes for the Better

Mitsubishi
Electric
MEQ quality

Wrap Yourself in Comfort and Quiet
Eco-conscious Technologies from Japan

Air to Water Catalogue
2022

Environmental Sustainability Vision 2050

Environmental Declaration

Protect the air, land, and water with our hearts and technologies to sustain a better future for all.



Environmental
Sustainability
Vision 2050

To solve various factors that lead to environment issues, the Mitsubishi Electric Group shall unite the wishes of each and every person, and strive to create new value for a sustainable future.

Three Environmental Action Guidelines

1

Apply diverse technologies in wide-ranging business areas to solve environmental issues

2

Challenge to develop business innovations for future generations

3

Publicize and share new values and lifestyles

Key Initiatives

- Climate Change Measures
- Resource Circulation
- Live in Harmony with Nature

- Long-term Activities
- Innovation
- Nurturing Human Resources

- Understanding Needs
- Co-create and Disseminate New Values
- Live in Harmony with the Region

Heat pump technology inspires Mitsubishi Electric to design air conditioners that harmonize comfort and ecology.

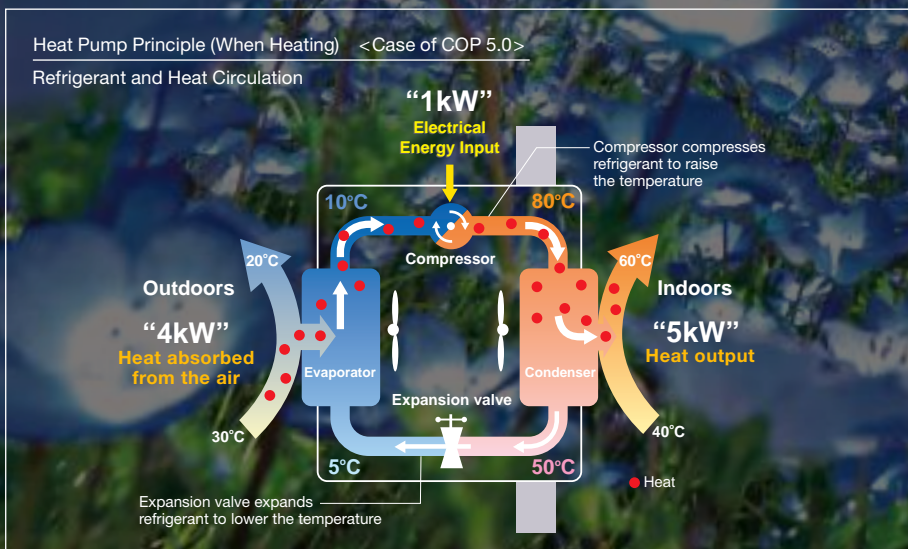

Mitsubishi Electric takes on the challenge of creating new value and contribute to a sustainable future in order to solve various environmental problems.

Preventing Global Warming

Mitsubishi Electric is actively introducing R32 refrigerant which has a global warming potential approximately 1/3 that of R410A refrigerant. Not only by shifting from R410A to R32 but by decreasing the diameter of refrigerant piping, we are also striving to reduce the amount of refrigerant usage. Through these activities, we have achieved significant reduction in CO₂ equivalent amount compared to conventional models and realized minimizing the negative impact to the environment more than ever.

Reducing the amount of refrigerant usage

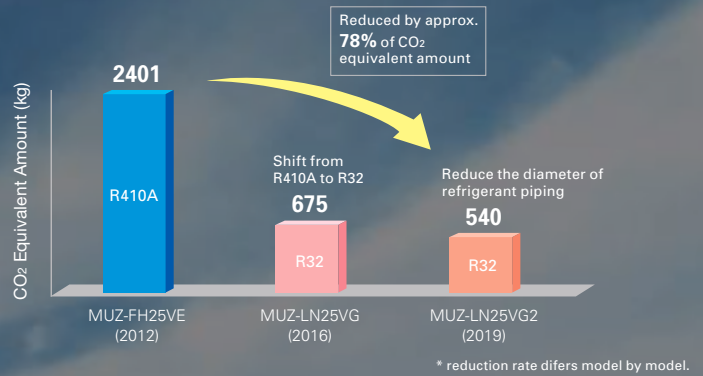

Effective use of materials (Reduce & Recycle)

1. Accelerating the downsizing technology to reduce material use while balancing energy saving performance.
2. Designing products that are easy to separate and recycle.
3. All models are designed for WEEE and RoHS (II) compliance.*

*WEEE and RoHS directive: The Waste Electrical and Electronic Equipment (WEEE) Directive is a recycling directive for this type of equipment, while the Restrictions of Hazardous Substances (RoHS) Directive is an EU directive restricting the use of ten specified substances in electronic and electrical devices. In the EU, it is no longer possible (from July 2019) to sell products containing any of the ten substances.

Balancing comfort and ecology

Mitsubishi Electric develops technologies to balance comfort and ecology, achieving greater efficiency in heat pump operation.

	Comfort	Ecology
1. Inverter	Faster start-up and more stable indoor temperature than non-inverter units.	Fewer On/Off operations than with non-inverter, saving energy.
2. 3D i-see Sensor	Since the positions of people can be detected, airflow can be set to personal taste, such as in airflow path or protected from the wind. The ability to adjust to individual preferences realizes more comfortable air conditioning.	Since the number of people in a room can be detected, energy-saving operation is adjusted or the power is turned off automatically. Efficient air conditioning with less waste is realized.
3. Flash Injection	Achieves high heating capacity even at low temperatures, plus faster start-up compared to conventional inverters.	Expands heat pump heating system to the cold regions to replace combustion heaters.
4. Dual Barrier Coating Dual Barrier Material	Prevents the indoor unit from getting dirty, delivering you clean air.	Keeping the inside of air conditioner clean leads to efficient operation and energy saving.

C

ONTENTS

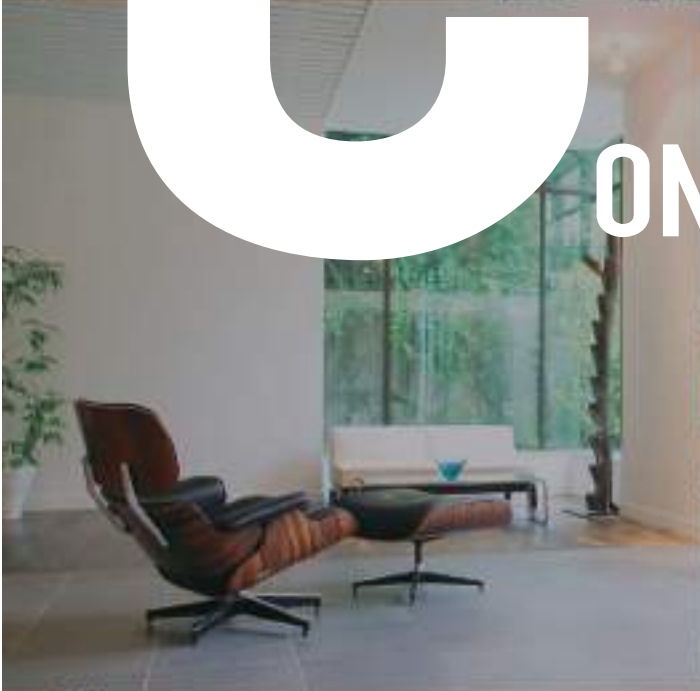

LINE-UP & FEATURES 007-030

SPECIFICATION 031-043

REFRIGERANT AMOUNT 045





AIR TO WATER



SELECTION

Choose the series that best matches the building layout.

Excellent ecodan's heating performance, even at low outdoor temperature!

R32 INDOOR UNIT

Hydro box, cylinder unit



OUTDOOR UNIT

Packaged type	Small capacity (Under 5kW)*	Medium capacity (6.0kW-14kW)*
		 PUZ-HWM140
	 PUZ-WM50	 PUZ-WM85/112
Split type	Small capacity (Under 5kW)*	Medium capacity (6.0kW-14kW)*
		 PUD-SHWM80/100/120/140
		 PUD-SWM80/100/120
Eco Inverter	 SUZ-SWM40/60	 SUZ-SWM80









*Rated capacity is at conditions A2W35. (according to EN14511)

R410A INDOOR UNIT





Hydro box, cylinder unit



OUTDOOR UNIT

Split type	Medium capacity (7.5kW-14kW)*	Large capacity (≥16kW)*
	 PUHZ-SHW80/112	 PUHZ-SHW140
		 PUHZ-SHW230
	 PUHZ-SW75/100	 PUHZ-SW120
		 PUHZ-SW160/200

*Rated capacity is at conditions A2W35. (according to EN14511)

Other ATW-related system	Mr.SLIM+	PUMY + ecodan
	  PUHZ-FRP71	  PUMY-P112/125/140

New Eco-design Directive

What is the ErP Directive?

The Eco-design Directive for Energy-related Products (ErP Directive) established a framework to set mandatory standards for ErPs sold in the European Union (EU). The ErP Directive introduces new energy efficiency ratings across various product categories. It affects how products such as computers, vacuum cleaners, boilers and even windows are classified in terms of environmental performance. Labelling regulations that apply to our ATW heat pumps came into effect from September 26, 2015, and then revised from September 26, 2019.

New energy label and measurements

Under directive 2009/125/EC, ATW heat pumps of up to 70kW are required to show their heating efficiency on the energy label. The purpose of the energy label is to inform customers about the energy efficiency of a heating unit. The efficiency for space heating is ranked from A+++ to D (from September 2019). In the case of domestic hot water, it is from A+ to F (from September 2019).

Product label

This label is for individual heating units, such as an ecodan heat pump. Typically, the space heater label is used for ecodan systems with a hydro box, and the combination heater label is used for ecodan systems with a cylinder unit.

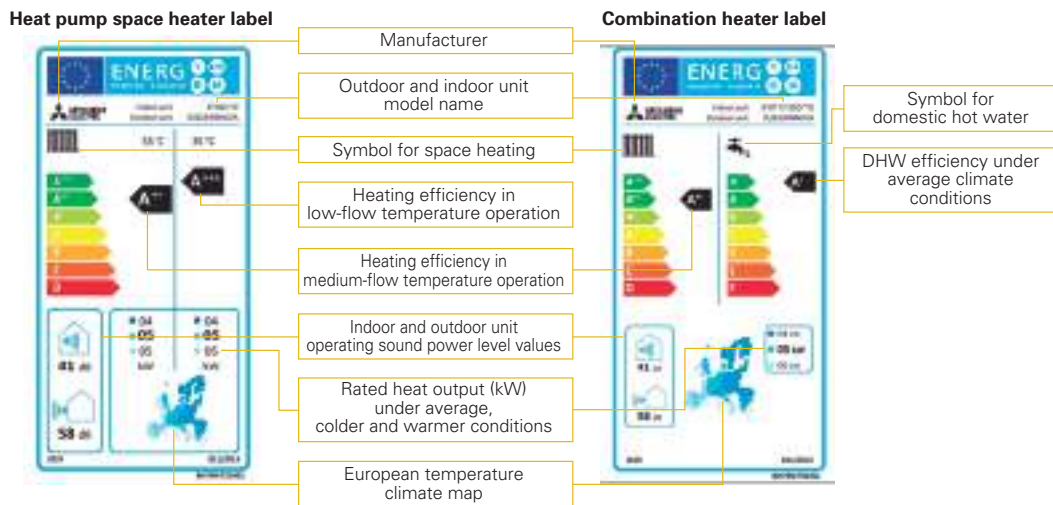

These labels are delivered with all ecodan outdoor units.

What is the package label?

A heating system can use several energy-related products, such as a controller or solar thermal system. Therefore, a label showing the efficiency of the total heating system is required. The category range is defined from A+++ to G.

Creating the package label is the responsibility of the installers and distributors. A useful tool on the Mitsubishi Electric website is available to easily create the labels for ecodan products and controllers.

<http://erp.mitsubishielectric.eu/erp/options>

Package label

This label is for heating systems that use several energy-related products, such as a controller or a solar thermal system.

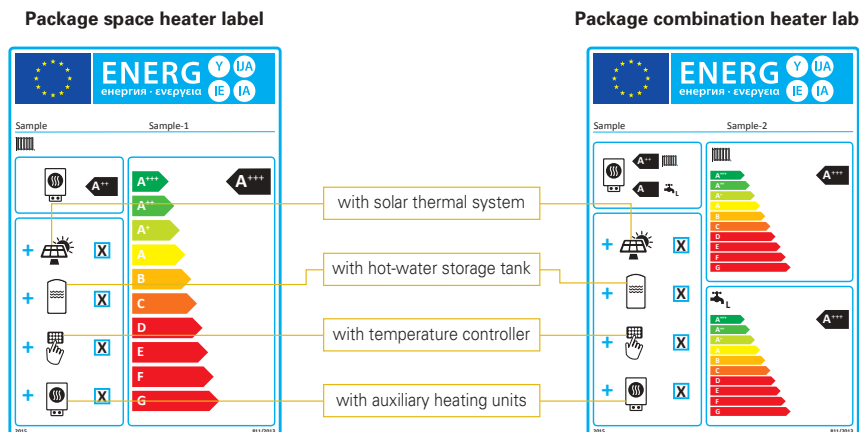

Customised package labels including ecodan heat pumps and the FTC6 controller can be created on the Mitsubishi Electric website.

New R32 Eco Inverter Line-up

Energy Efficient and Environmentally Friendly Heating

- Wide variety of product line with R32 refrigerant
- More energy efficient than conventional eco inverter models



High Performance

All models have achieved the "RANK A+++" for SCOP at low temperature.

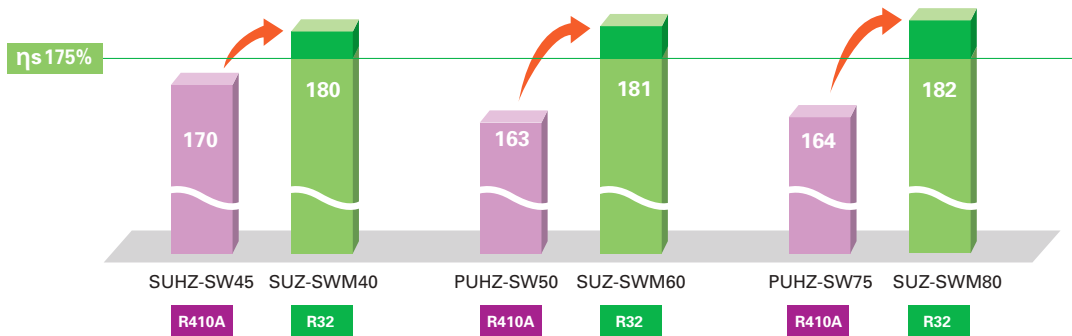

Low Noise

Compared with conventional outdoor unit, New R32 eco inverter achieved lower noise level, assuring the flexibility of installation in dense residential areas.

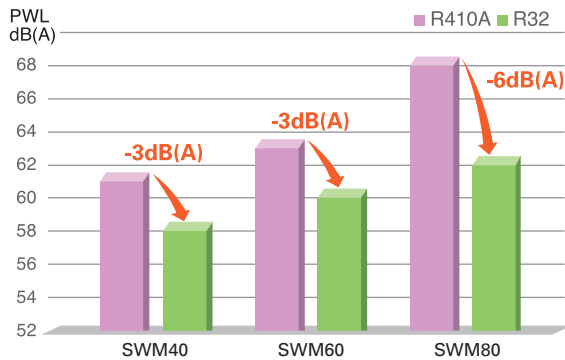

*Compared SUZ-SWM40/60/80VA with SUHZ-SW45VA/PUHZ-SW50VKA/PUHZ-SW75VHA
*Rated condition (According to EN12102)

60°C Flow Temperature

Along with its increased lower operating range the New R32 range is capable of delivering a higher flow rate of 60°C, 5°C higher than the conventional model.

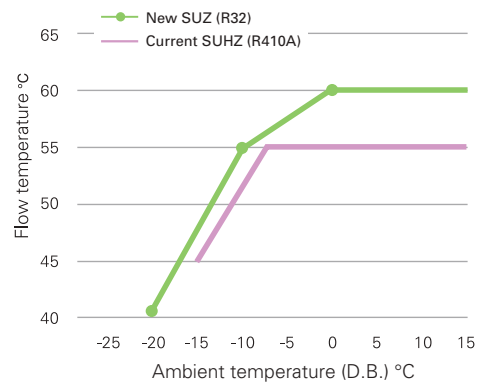

Guaranteed Operating Range Expansion

Guaranteed heating operating range is extended to -20°C.

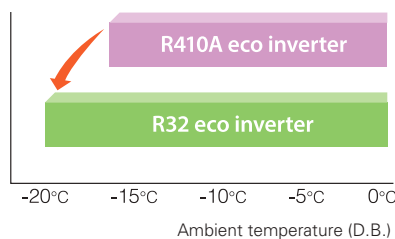

Reducing Refrigerant Amount

<R410A vs R32> CO₂ equivalent emission

CO₂ equivalent emission less than 1/3* depending on the model!

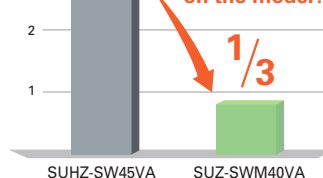

Model name	SUHZ-SW45VA	SUZ-SWM40VA
Refrigerant amount	1.3kg	1.2kg
GWP	2088 (R410A)	675 (R32)
t-CO ₂ eq	2.714	0.810

*Source: IPCC 4th Assessment Report, global warming potential (GWP) 100-year value. Comparison of 2088 (R410A) and 675 (R32).

Dedicated Heat Pump for Residence



Stylish and Compact

The Stylish Design and Compact Size Harmonises Residential Application

- Simple and elegant design by rounding left and right corners of the unit.
- Concealing the fan by matching the panel and the grille in dark colour.
- Unified shape and safety by setting the fan whole backwards and matching the grille on the same level of the front panel.
- Wider lineup with environmental-friendly R32 refrigerant.

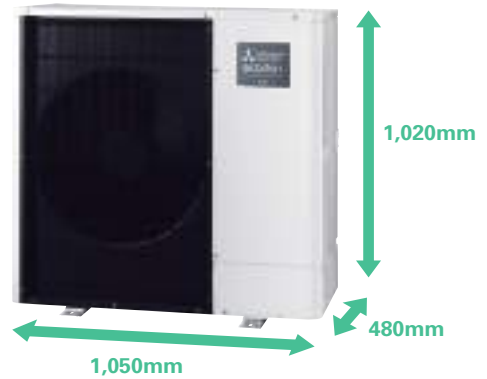

High Performance

New Compressor



- Compact
 - High performance
 - Flash injection*
- *ZUBADAN (SHWM) only



ErP Lot 1 Compliant with Highest Seasonal Space Heating Energy Efficiency Class A+++

All models have achieved the "RANK A+++ " for SCOP at low temperature.

Heating

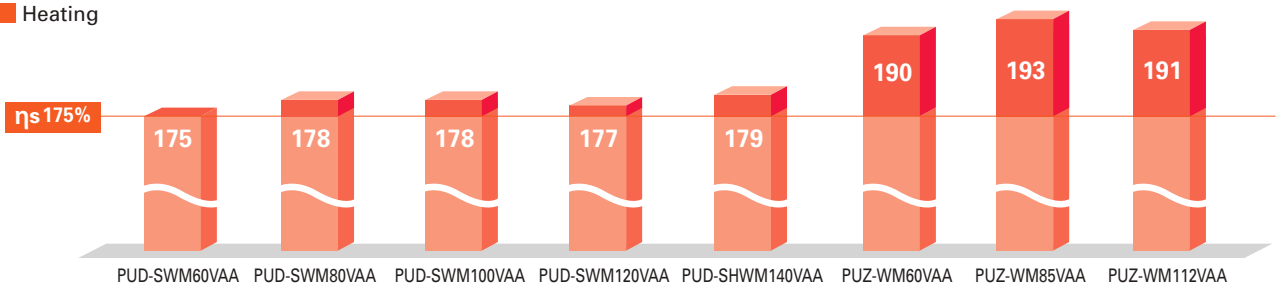

60°C Flow Temperature at Low Ambient Temperature

60°C max flow temperature can be maintained up to Ambient -7°C. (For PUD-S(H)WM models)

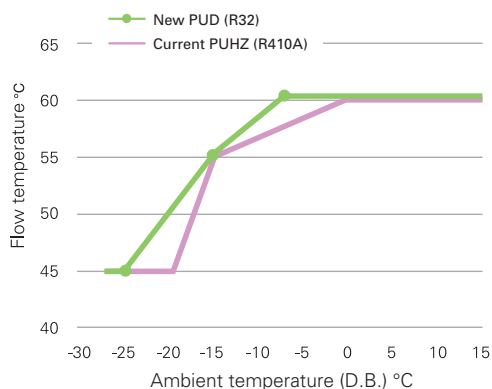

Reducing Refrigerant Amount

<R410A vs R32> CO₂ equivalent emission

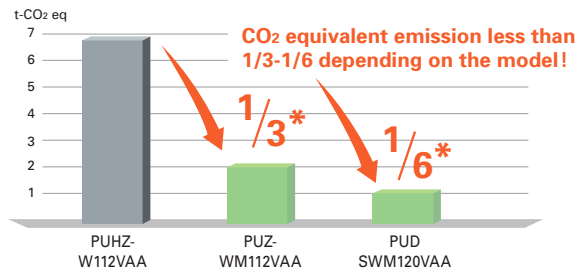

Model name	PUHZ-W112VAA	PUZ-WM112VAA	PUD-SWM120VAA
Refrigerant amount	3.3kg	3.0kg	1.6kg
GWP	2088 (R410A)	675 (R32)	675 (R32)
t-CO ₂ eq	6.890	2.025	1.080

*Source: IPCC 4th Assessment Report, global warming potential (GWP) 100-year value. Comparison of 2088(R410A) and 675 (R32).

Compact with Silence

Noise Reduction-10dB(A)

Mitsubishi Electric heat pumps are designed to give you highly efficient and eco-friendly heating with 10dB(A) less in PWL. Compared with conventional models.

* Rated condition (According to EN12102)

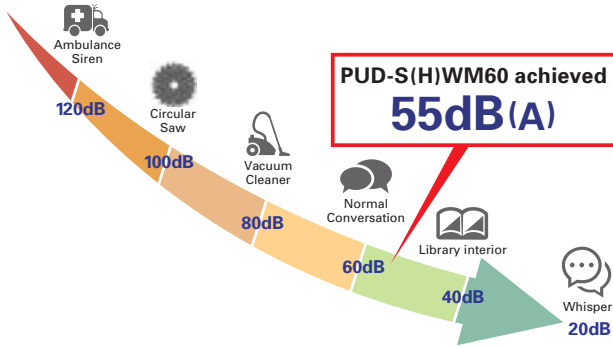

Blowing Air

To Reduce Fan Noise

- Optimising fan position
- Optimising bell mouth shape
- Bigger fan diameter

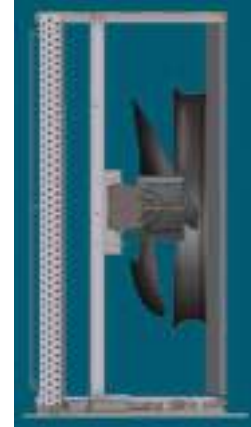

Enclosing Noise

Shutting Out Noise from Compressor

- The structure of double enclosing

Primary: enclosing a compressor (the structure is patented.)
Secondary: enclosing machine room.



Avoiding Vibration and Resonance

- Dedicated soft rubber mount for the compressor to avoid vibration.
- Optimising piping structure to avoid vibration and resonance.



New Control for Eco-friendly Heating

Defrost Improvement

Conventional models often switch to defrost operation even when there is not much frost on outdoor units. By detecting frost more precisely, it is possible to prevent frequent on/off for defrosting and to give you more comfort.

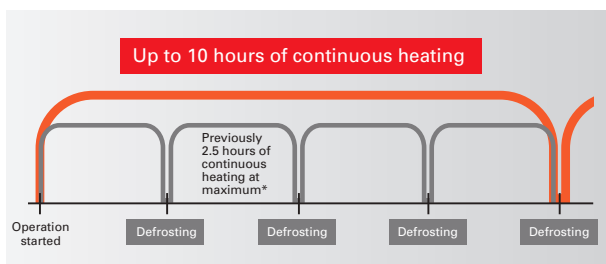

* Comparison between prior PUHZ-SHW-AA model and new PUD-S(H)WM-AA model.
Maximum number of operational hours at our Company's laboratory (external temperature -15°C).
Hours of continuous operation may differ depending on external temperature conditions.

New Compressor Frequency Control

By reducing frequency changes (from 17 to 4 times per hour), hunting is prevented. Reducing fluctuation improves efficiency and prolongs compressor life.

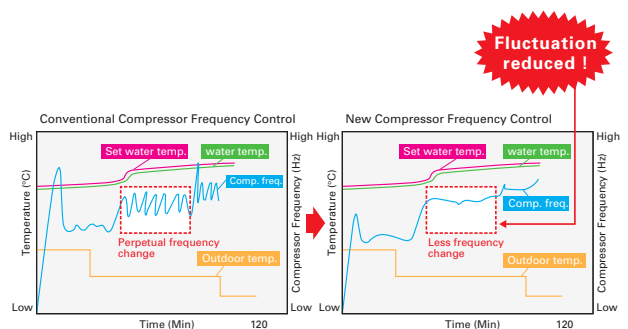

D generation Indoor Unit

All-in-one Compact Indoor Unit

- All-in-one: Key functional components are incorporated
- Compact cylinder unit: 1,400~2,050mm in height
- Compact hydro box: Only 530×360mm footprint
- Easy installation: Factory fitted pressure relief valve
- Easy service: Relevant parts are located at the front of the unit for easy maintenance
- Easy transport: Handles attached on front and back (cylinder unit)

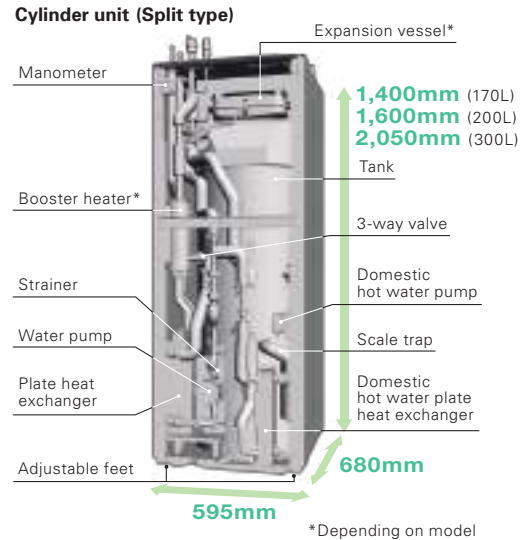
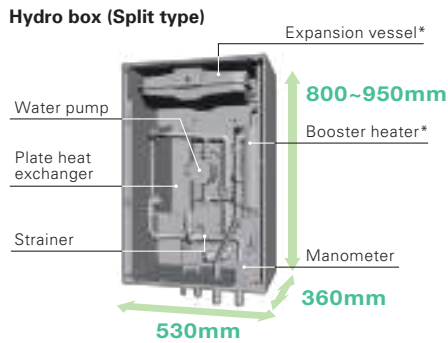

*Depending on model

Line-up

ecodan's line-up has many types of indoor units to satisfy diverse customers' needs, requests and local regulations. It includes various capacity units, with/without booster heater, with/without an expansion vessel, etc. In addition, a reversible hydro box and a reversible cylinder unit are available.

Hydro box



Cylinder unit



Reversible Models

(for heating/cooling)

Perfect Comfort in Winter and Summer Time, Thanks to Our Reversible Models.

Reversible models are now available for both hydro box and cylinder units (Both for split type and cylinder unit for packaged type). The new reversible cylinder is now able to produce cold water for cooling use and can alternatively produce domestic hot water in summer time.

Reversible hydro box



Reversible cylinder unit



Available options

- Packaged or Split type
- With/without booster heater
- With/without expansion vessel
- Cylinder unit has an integrated 170L/200L/300L stainless steel tank
- Hydro box is control ready for domestic hot water with a stand-alone tank (locally supplied)

Easy Installation and Low Maintenance

Simple Piping Arrangement

All water piping is aligned at the rear side of the unit for easy connection and neat finish.



Easy Adjustment

Adjust bolt capable of 50mm expansion for easy installation on uneven surfaces.



Built-in Drain Pan for Reversible Cylinder Models

Reversible models now include a built-in space saving drain pan and the drain socket is positioned at the back of the unit. With use of the adjuster bolt, the outlet height can be higher than 50mm, allowing 5m drainage.



Initial Setting Wizard

In addition to language, date and time, you can set up hot water and heating/cooling operation, pump speed, flow rate range initial setting much simpler than previous models.

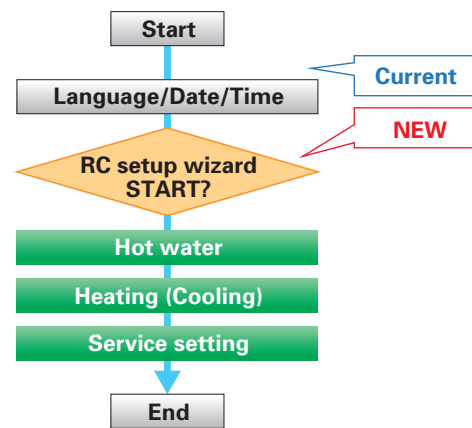

Hydro Box Piping Arrangement Improvement

Through structural innovation related to the space around the pipes, the area where the spanner can be moved has been increased, thus improving pipe work and enabling it to be completed smoothly.

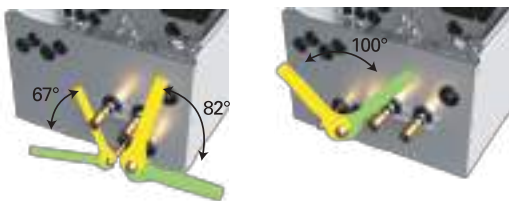

Operation Data Monitoring

Time, operation mode, flow/return/tank temperature, can be displayed on main remote controller.

Sample display of monitoring setting

26 Feb 2019 10:00				
	THW1	THW2	THW5	Flow
10:00 ☀	41°C	38°C	54°C	20L
9:55 ☀	38°C	38°C	54°C	20L
9:50 ☀	48°C	48°C	54°C	20L
9:45 🚰	60°C	56°C	54°C	15L
9:40 🚰	59°C	55°C	52°C	15L
i ◀ ▶				(1/5)

Minimum Additional Water Required

In average/warmer conditions, minimum additional water is required for outdoor unit. If there is enough water amount inside water pipe, radiator, or underfloor heating no buffer tank is required.

*Refer to the indoor unit installation manual for specific outdoor unit models.

2 Zone Kit

You can select from 3 types of pump operations, 1. Fixed speed mode, 2. Fixed pressure mode, 3. Energy saving mode, depending on your preference.



- All-in-one kit: Key functional components are incorporated in 2 zone kit.
- Easy installation: G1 screw type flex-piping to avoid brazing.
- Compact size: Just to fit on the top of cylinder unit, also wall mountable.

High Performance

Improved Efficiency

With additional thermistor (THW5A), η_{wh} [%] rating is improved by more than 40% compared to previous C generation 200L models allowing 170L and 200L to achieve A+, the highest possible domestic hot water efficiency rank.

Excellent DHW efficiency



	170L	200L	300L
	η_{wh} [%]	η_{wh} [%]	η_{wh} [%]
Conventional	–	96~104	–
New	120~148	135~159	118~128
Load Profile	L	L	XL
DHW Rank	A+	A+	A/A+

Thermistor Position of Cylinder

The thermistor position is now selectable allowing the unit to accommodate for different water demands in order to maximise the efficiency of the unit for any size of household or application. Using two thermistors equipped with all sizes of tanks, you can now select the DHW recharge amount from two options (Standard/Large). It helps accommodate for different water demands in order to maximise the efficiency of the unit for any size of household or application. This mode can be selected from main remote controller.

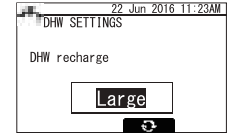
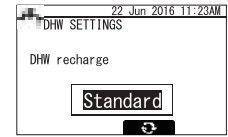

Unique Technology of ecodan

Auto Adaptation

Maximise Energy Savings While Retaining Comfort at All Times

Regarding the relation of flow temperature and unit performance, a 1°C drop in the flow temperature improves the coefficient of performance (COP) of the ATW system by 2%. This means that energy savings are dramatically affected by controlling the flow temperature in the system.

In a conventional system controller, the flow temperature is determined based on the pre-set heat curve depending on the actual outdoor temperature. However, this requires a complicated setting to achieve the optimal heat curve.

■ Heat curve setting (Example)

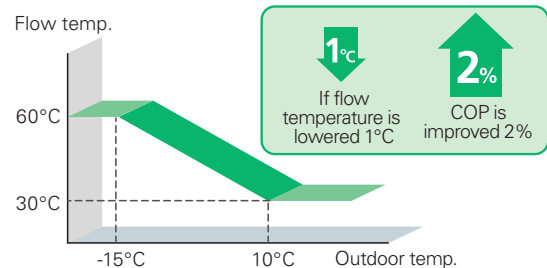

*SD logo is a trademark of SD-3C, LLC

Auto Adaptation Improvement

Mitsubishi Electric's Auto Adaptation Function Automatically Tracks Changes in the Actual Room Temperature and Outdoor Temperature and Adjusts the Flow Temperatures Accordingly.

Aiming to realise further comfort and energy savings, Mitsubishi Electric has already introduced a revolutionary new controller. Auto Adaptation function measures the room temperature and outdoor temperature, and then calculates the required heating capacity for the room. Simply stated, the flow temperature is automatically controlled according to the required heating capacity, while optimal room temperature is maintained at all times, ensuring the appropriate heating capacity and preventing energy from being wasted.

Furthermore, by estimating future changes in room temperature, the system works to prevent unnecessary increases and decreases in the flow temperature. Accordingly, Auto Adaptation maximises both comfort and energy savings without the need for complicated settings.

For Mitsubishi Electric ecodan, by introducing improved control logic, we achieved faster heating and more energy saving.

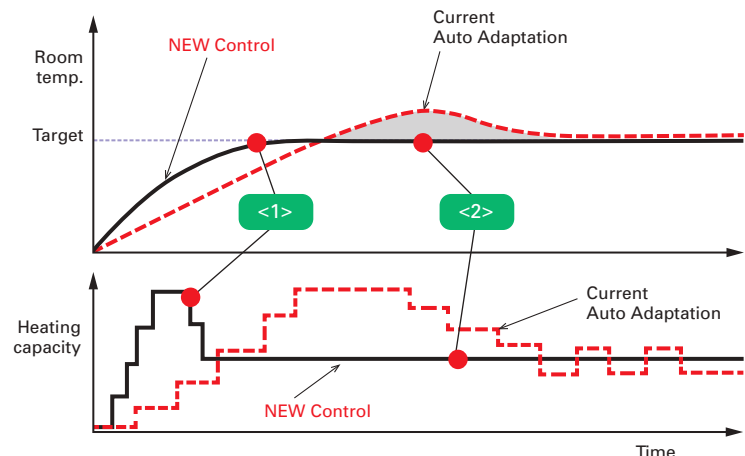

<1> Fast heating with improved accuracy in learning building heat load
 <2> Energy saving by avoiding over heating and capacity fluctuation with better control response, i.e. control interval and resolution

Smart Grid Ready Function

In recent years renewable energy generation has become popular. However, this rapid growing causes the problem of supply and demand gap of electricity. The aim of "SG Ready" is to make the electricity demand response more flexible by creating a uniform interface for the smart grid integration of heat pumps. Air-to-Water units need to be able to change the operation pattern when the signal is received from the Smart Grid Controller.

New ecodan Cylinder, Hydro box and FTC have been modified to communicate with Smart Grid Controller. The communication protocol is based on "SG Ready" label regulation. (Version 1.1; gültig ab 01.01.2013)

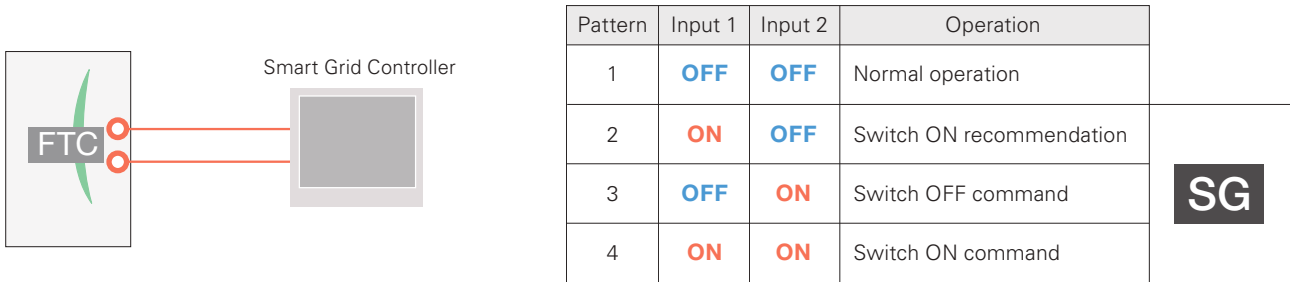

Pattern 1: Normal operation

When there is no signal from the Smart Grid Controller, DHW and Heating operate according to user settings.

Pattern 2: Switch ON recommendation

When set to the "Switch ON" recommendation, the target temperature of DHW is increased a specified amount and the heating "Thermo ON" condition range is extended.

Pattern 3: Switch OFF command

When the "Switch OFF" command is received, both DHW and Heating are turned off.

Pattern 4: Switch ON command

When the "Switch ON" command is received, the target temperature of DHW is increased to the maximum target temperature and Heating continues.

Improved Smart Grid Ready

SG ready icon on main remote controller indicates that SG ready is active and its setting can be easily operated with main remote controller. Improved SG ready function enables you to choose the target temperature in unit of 1°C. Also, when PV manager is interlocked with ecodan and ecodan receives its signal, heat is stored as much as possible while heat pump and/or electric heater running.

Heat storage in large buffer tank will be made available for zone2 as well when peak cut signal is on. As long as a mixing valve keeps its control, zone2 flow temperature is maintained.



Pattern	Operation	R/C indication
1	Normal operation	—
2	Switch ON recommendation	SG
3	Switch OFF command	
4	Switch ON command (while PV is generating)	

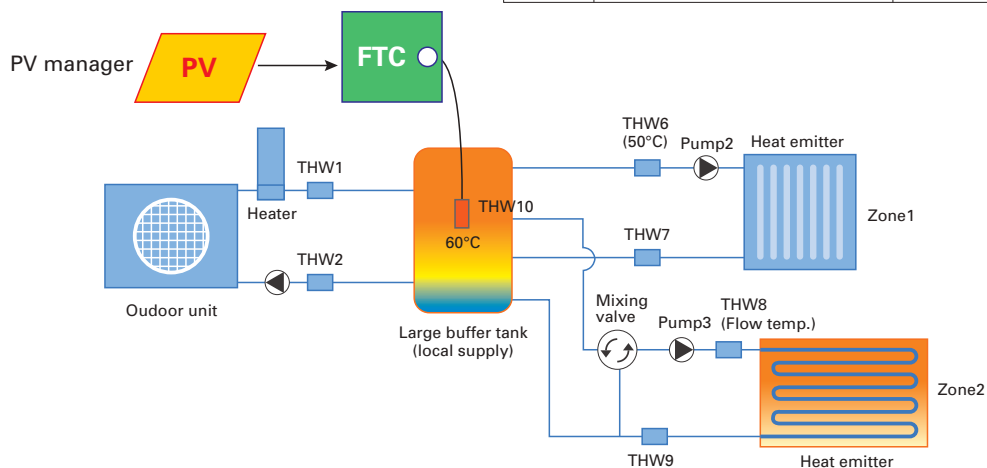



*SD logo is a trademark of SD-3C, LLC

Intelligent Hybrid Control (boiler interlock)

An Existing Boiler Can Be Used for Extra Heating Capacity in an Efficient Way

The flexibility of ecodan's intelligent control allows the system to be combined with the boiler currently in use. Additionally, this control can judge which heating source to use either ecodan or the existing boiler, based on various conditions*.

In the event of one heating unit not working due to some unforeseen problem, the other heating system can be used as a back-up, thereby preventing the heating system operation from stopping completely.

*Please see below "Heat source switchover".

Intelligent system combining a boiler with ecodan

■ Intelligent boiler interlock system

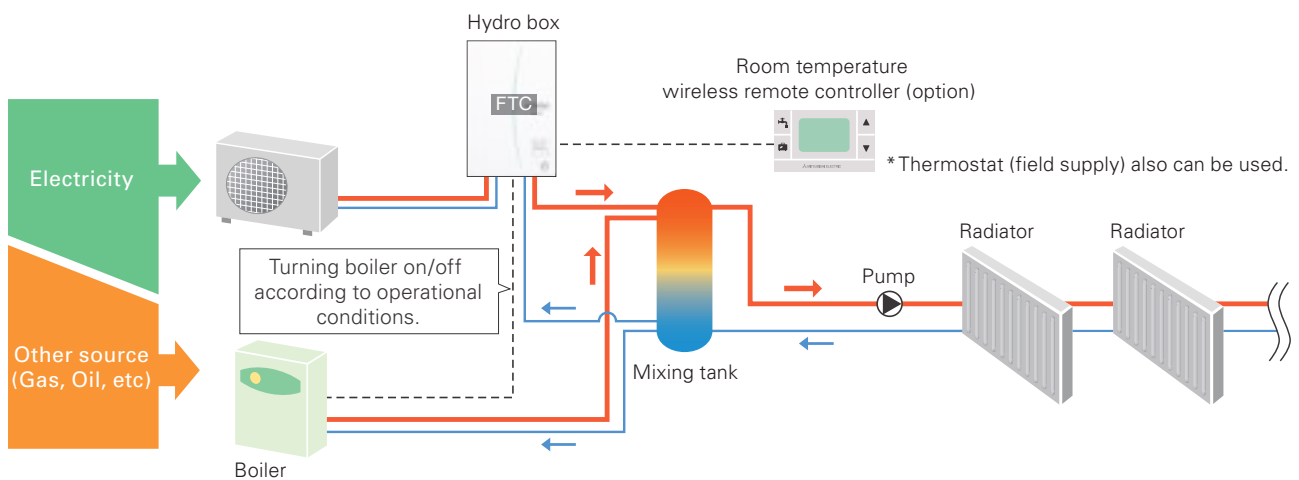

* Items such as a mixing tank, and pump are not included and need to be purchased locally.

Heat source switchover - Choose appropriate system based on needs

4 types of heat source switchover logic

- ① Switchover based on actual outdoor temperature
 - Heat source switchover occurs when the outdoor temperature drops below a pre-set temperature.
- ② Switchover based on running cost
 - Heat source switchover occurs by judging optimal operation based on running cost.
 - *Pre-registration of the energy price of electricity, and gas or oil per 1kWh is necessary.
- ③ Switchover based on CO₂ emission level
 - Heat source switchover occurs to minimise CO₂ emission.
 - *Pre-registration of CO₂ emission amount from electricity and gas or oil is necessary.
- ④ Switchover can also be activated via external input
 - For example, the peak cut signal from electric power company.



*SD logo is a trademark of SD-3C, LLC

2 Zone Control (for heating/cooling)

Improved Simultaneous Control of Two Different Zones

Using ecodan, it is possible to control two different flow temperatures, thereby managing two different heating load requirements. The system can adjust and maintain two flow temperatures when different temperatures are required for different rooms; for example, controlling a flow temperature of 40°C for the bedroom radiators and another flow temperature of 30°C for the living room floor heating.

Moreover, mixing valve control is advanced for improving zone 2 comfort by using heat storage in buffer tank. Also, new controller monitors the temperature inside buffer tank and prioritizes using the heat inside the tank to avoid frequent on/off operation when using 2 zone control.

■ Two temperature zones

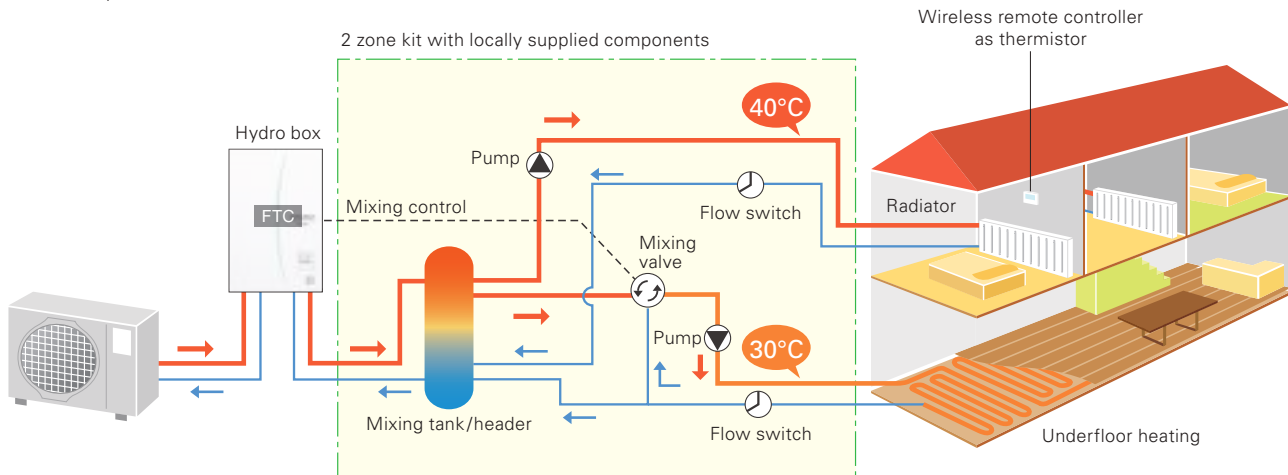

*Items such as a mixing tank, mixing valve flow switch and pumps are not included and need to be purchased locally.

Multiple Unit Control

Connect up to 6 Units – Automatic Control of Multiple Units for Bigger Capacity and Better Efficiency

A maximum of 6 units* can be configured according to the heating/cooling load of the building. The most efficient number of operating units is determined automatically based on heating/cooling load. This enables ecodan to provide optimal room temperature control, and thus superior comfort for room occupants. Also incorporated is a rotation function that enables each unit to run for an equal time period.

If one of the units malfunctions when using the Multiple Unit Control, another unit can be automatically operated for back-up, thereby preventing the system operation from stopping completely.

*Only same models (same capacity) can be used.

■ Multiple unit control

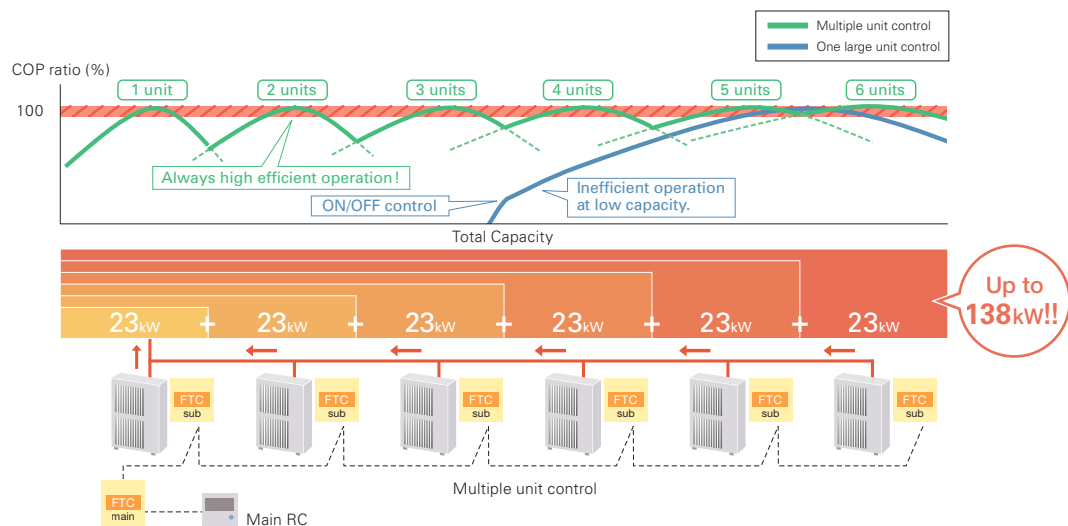

Remote Controllers

Smart User-friendly Controller with Stylish Design

Main remote controller

- Large screen and backlight for excellent visibility, even in dark environment
- Multi-language support (supports 15 languages)
- Can be removed from main unit and installed in a remote location (up to 500m)
- Quick reading of operation data (7.5 times faster than previous model)
- Wide range of convenient functions in response to user demand

Function settings

- Energy monitoring
- Two-zone control (cooling and heating)
- Two separate schedules
- Summer time setting
- Built-in room temperature sensors
- Hybrid control (boiler interlock)
- Floor drying mode
- Weekly timer
- Holiday mode
- Legionella prevention
- Error codes

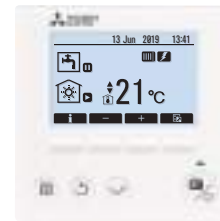

Main controller



PAR-WR51R-E (Option) Receiver



PAR-WT50R-E (Option) Wireless remote controller

Wireless remote controller (optional)

- Built-in room temperature sensor; easy to place in the best position to detect room temperature
- Wiring work eliminated
- Simple design that is easy to operate
- Remote control from any room without needing to choose an installation location
- Backlight and big buttons that are easy to operate
- Domestic hot water boost and cancellation
- Simplified holiday mode



*SD logo is a trademark of SD-3C, LLC

Energy Monitoring

View Electricity Consumption and Heat Output on the Remote Controller

Every end user can now easily check the energy data of the ecodan heat pump.

Other features

- Daily, monthly and yearly data are stored and can be displayed using the main remote controller.
- External power meter and heat meter can be connected for accurate measurement.
- SD card is also available for storing data.

*Using pre-set values on the main remote controller, estimated energy consumption/output can be shown without external power and a heat meter.

Depending on operating condition and system configuration, there is some possibility to show different data from the reality.

*This function is available depending on the version of the outdoor unit model.

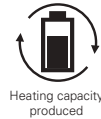

Heating capacity produced



Electric energy used

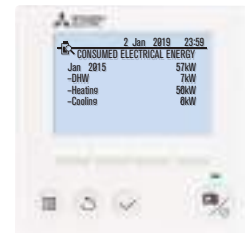

*SD logo is a trademark of SD-3C, LLC

Summer Time Setting

Easy Adjustment for Summer Time

Just switch the summer time mode 'on' using the main remote controller and the clock in the main remote controller is adjusted to summer time hours.

This function can release the end user from clock setting tasks.

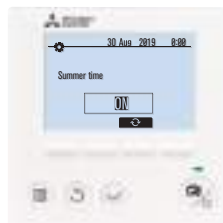

Two Separate Schedules

Pre-setting Two Different Schedules for Winter and Summer Seasons

Two different schedule settings are available for use via the main remote controller.

These schedules can be pre-set and changed depending on the season. For example, from November to March, space heating and domestic hot water are used; however, during warm months such as from April to October, only domestic hot water is used.



<Example>

Schedule 1	Winter time
Space heating	daytime
Domestic hot water	early morning
Schedule 2	Summer time
Domestic hot water	any time

Easy Commissioning

Pump for Primary Water Circuit* Speed Setting Possible Using ecodan's Main Remote Controller

Even when the system is running, pump output can be set to one of five different settings using the main remote controller.

The person commissioning the system can adjust this speed much more easily.

*Speed setting of pump for domestic hot water is not available through the main remote controller when the system is running.

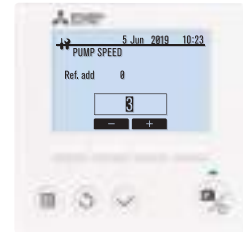

Flow sensor newly incorporated

The flow sensor is key for monitoring energy output and can also be used to detect flow error as well.

– Flow rate can be checked on the main remote controller.

– Flow rate can also be shown as graphs using the SD card tool.



Run indoor unit* without outdoor unit

During installation or situations such as an outdoor unit malfunction, the indoor unit can be operated using a heater.

While using this mode, flow and tank temperature are selectable.

Fixing and maintenance of the outdoor unit can be done without stopping heating and domestic hot water operation*.

*Models with electric heater only.

*When the indoor unit operation stops, please check all settings after the outdoor unit is connected.



*SD logo is a trademark of SD-3C, LLC

SD* Card

For Easier Settings and Data Logging

The initial setting for ecodan is now simpler than ever before. The special software enables the required initial settings to be saved to an SD card using a personal computer. The system set-up is as easy as moving the SD card from the computer to the SD card slot in the indoor unit. Compared to the previous procedure of inputting settings using the main controller at the installation site, a remarkable reduction in set-up time has been achieved. Thus, it is ideal for busy installers.

*SD card function is only used at the time of installation.

Hydro box operation panel

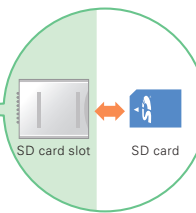
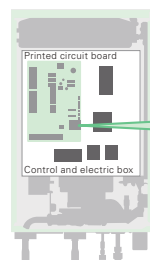

Settings can be performed easily and the logging of operation data saved to an SD card can be confirmed via a personal computer.



Items that can be pre-set

Simply copying pre-set data to an SD card, the same settings can input into another unit using the SD card.

- Initial settings (time display, contact number, etc.)
- Heating settings
 - Auto adaptation
 - Heat curve
 - Two different temperature zones (heating and cooling)
- Interlocked boiler operation settings
- Holiday mode settings
- Schedule timer settings (two separate schedules)
- Domestic hot water settings
- Legionella prevention settings

All items that are set by the main controller can be set via a personal computer.

Data that can be stored

Operation data up to a month long can be stored on a single SD card

- Consumed electrical energy
- Delivered energy
- Flow rate
- Operation time
- Defrost time
- Actual temperature
 - Room temperature
 - Flow temperature
 - Return temperature
 - Domestic hot water temperature
 - Outdoor temperature
- Error record
- Input signal
- Etc.

ZUBADAN SERIES

The ZUBADAN Series incorporates an original Flash Injection technology that improves the already high heating capacity of the system. This new member of the series line-up ensures comfortable heat pump-driven heating performance in cold regions.



* Units in photo are Japanese models.
European model specifications are different.

Improved Heating Performance

Mitsubishi Electric's unique "Flash Injection" circuit achieves remarkably high heating performance. This technology has resulted in an excellent heating capacity rating in outdoor temperatures as low as -15°C , and the guaranteed heating operation range of the heating mode has been extended to -25°C . Accordingly, the heat-pump units of the ZUBADAN Series are perfect for warming homes in the coldest of regions.

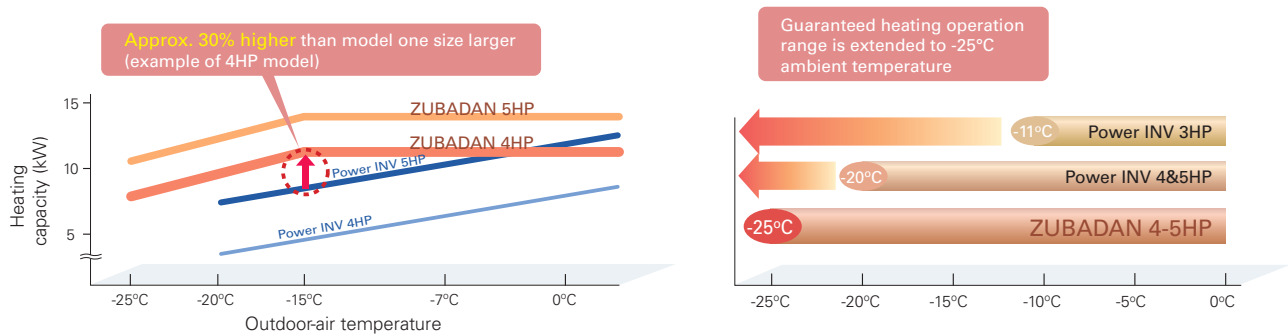

Enhanced Comfort

The Flash Injection circuit improves start-up and recover from the defrosting operation. A newly introduced defrost operation control also improves defrost frequency. These features enable the temperature to reach the set temperature more quickly, and contribute to maintaining it at the desired setting.

Quick Start-up

■ Operation at $+2^{\circ}\text{C}$ outdoor temperature

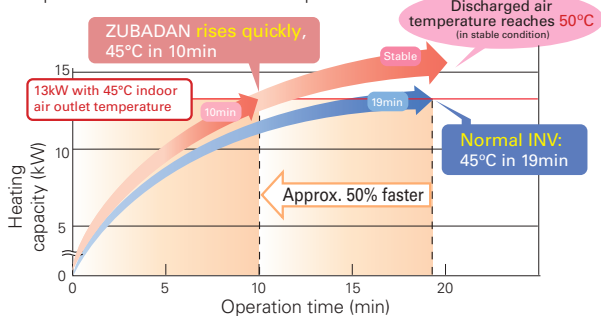

■ Operation at -20°C outdoor temperature

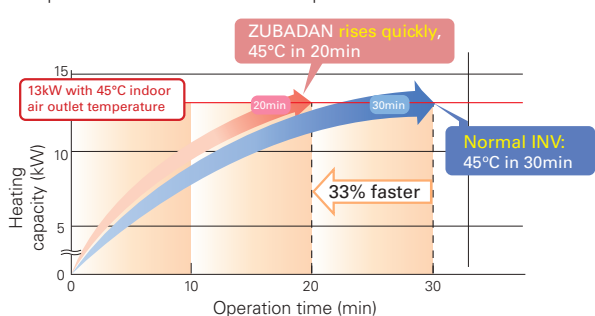

ZUBADAN Defrost Control and Faster Recovery from Defrost Operation

Field Test Results: Office building in Asahikawa, Hokkaido, Japan

■ Operation data for 25 Jan. 2005

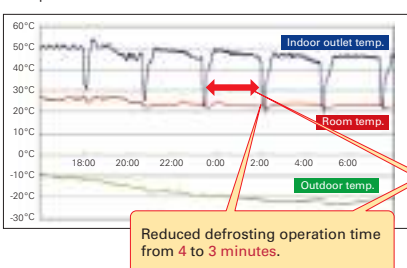

■ Operation data for 2 Dec. 2004

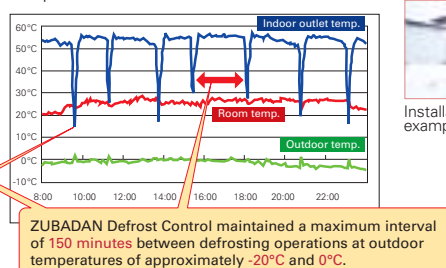

Installation example



Mitsubishi Electric's Flash Injection Technology The Key to High Heating Performance at Low Outdoor Temperatures

Flash Injection Circuit

ZUBADAN

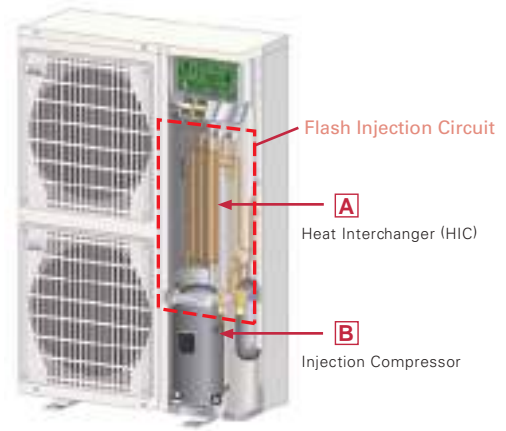
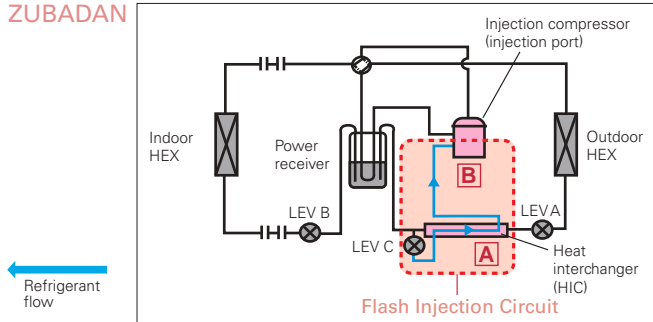

The ZUBADAN Series is equipped with Mitsubishi Electric's original Flash Injection Circuit, which is comprised of a bypass circuit and heat interchanger (HIC). The HIC transforms rerouted liquid refrigerant into a gas-liquid state to lower compression load. This process ensures excellent heating performance even when the outdoor temperature drops very low.

In traditional units, when the outdoor temperature is low, the volume of refrigerant circulating in the compressor decreases due to the drop in refrigerant pressure and the protection from overheating caused by high compression, thereby reducing heating capacity. The Flash Injection Circuit injects refrigerant to maintain the refrigerant circulation volume and compressor operation load, thereby maintaining heating capacity.

Mollier Chart Image Representing Flash Injection Circuit Operation

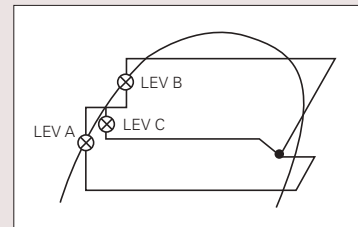

A Heat Interchanger (HIC)

HIC cross-sectional view

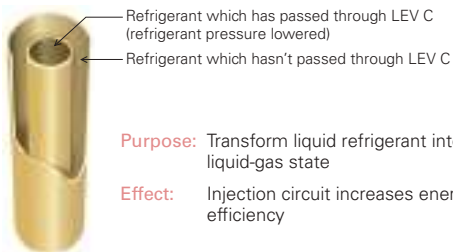

The compressor is subjected to a heavy load when compressing liquid refrigerant, and the result is lower operation efficiency. The addition of HIC supports refrigerant heat exchange at two different pressure levels. The heat-exchange process transforms the injected liquid refrigerant into a gas liquid state, thereby decreasing the load on the compressor during the compression process.

B Injection Compressor

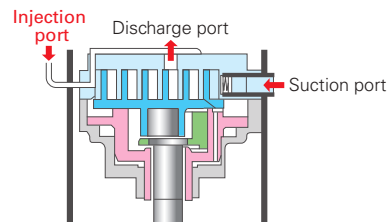

Purpose: To increase the volume of refrigerant being circulated

Effect: Improves heating capacity at low outdoor temperatures, and enables higher indoor-air outlet temperature adjustment and higher defrost operation speed

Refrigerant passes from the HIC into the compressor through the injection port. Having two refrigerant inlets makes it possible to raise the volume of refrigerant being circulated when the outdoor temperature is low and at the start of heating operation.

To ensure full capacity in cold and snowy regions...

3 Important Points to Remember When Installing the Outdoor Unit



* RAC/PAC (inc. Air to Water) /MXZ

Wind and snow can significantly reduce capacity.

Be sure to check the information below and install the outdoor unit correctly.

1 Installation Location

Be aware of the prevailing wind direction in winter and install the outdoor unit where it is as sheltered as possible.

Units are easily affected by wind and unit may not be able to run at full capacity

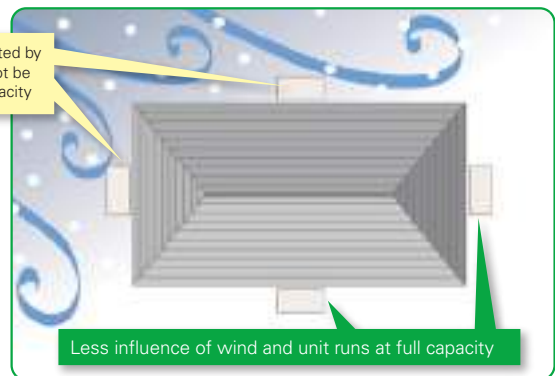

2 Measures for Drainage of Water

Case 1: Unit is installed close to passage (walkway)

Do not install the unit close to passage as drainage water from the unit may freeze and cause a slipping hazard.

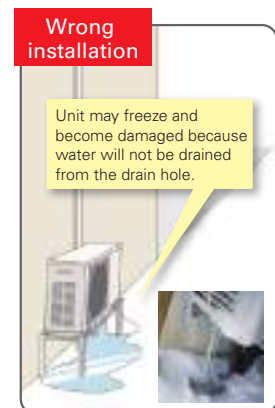
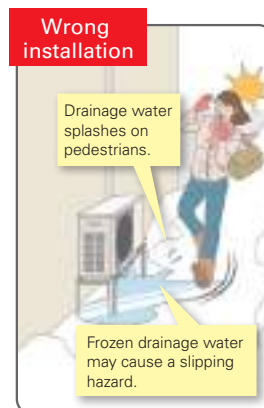
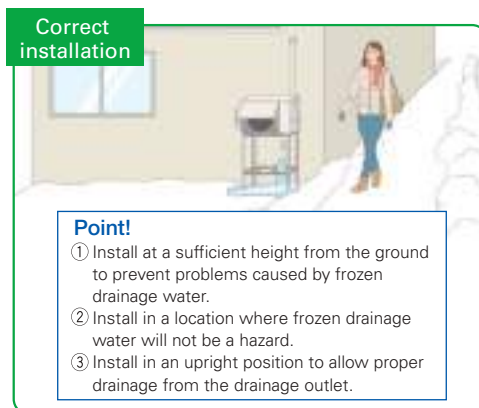

Case 2: Multiple units are installed

Do not install units on top of one another as it may cause frozen drainage water on the bottom unit.

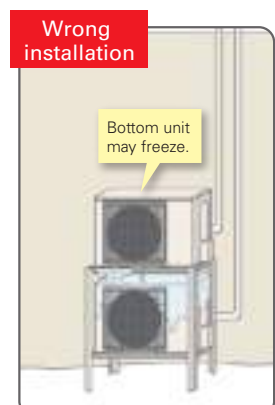
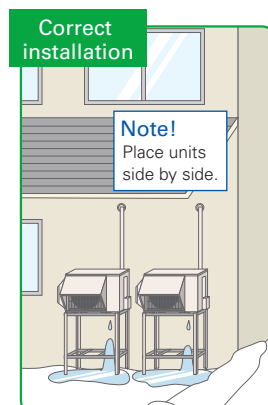

3

Measures for Snow

Unit is installed on the ground

To avoid the adverse effects of snow and frozen drainage water, install the unit on a stand to ensure a sufficient height from the ground.

Correct installation

Point!

- ① Install at a position/height to prevent the unit being buried in snow*1 and the adverse effects of frozen drainage water.*2
- ② Install so as to avoid the effects of snow or snowdrift.
- ③ Install so as to avoid the damage from falling snow or icicles.

*1 Install at a height above the highest snowfall depth.
*2 Even for correct installations, dripping drainage water may form an icicle which needs to be cleared away regularly to prevent a blocked drainage outlet.

Wrong installation

Unit may become buried in snow due to heavy snowfall, snow sliding off the roof or snowdrift.

Wrong installation

Unit may be damaged due to snowfall or icicles.

Use a stand to add sufficient height to protect the unit heat exchanger from snow and prevent icicles forming during defrost operation.

Install snow protection hood as necessary

Correct installation

Minimum height (h) should be higher than the highest snowfall depth (h0) **+20cm**

Wrong installation

Unit may become covered in snow if the stand height is insufficient.

Correct installation

Point!
Install the snow protection hood or other cover in snowy regions.

Necessity of accessories (drain socket & centralised drain pan, stand, snow protection hood, base heater)

	Snowy region	Cold region	Remarks
	Countermeasures for snow	Countermeasures for freezing	
Drain socket, Centralised drain pan	Not used	Not used	Prevents freezing
Stand	Needed	Needed	<ol style="list-style-type: none"> 1. Install so as to prevent the unit being buried in snow (at a height greater than the highest snowfall depth). Be sure that the stand does not obstruct drainage. 2. Install so as to prevent damage to the unit due to frozen drainage water (icicles). <div style="text-align: right;"> <p>Clearance to prevent snow accumulating. < Correct ></p> </div>
Snow protection hood	Needed *When the installation position is subject to snowfall.	—	<ol style="list-style-type: none"> 1. Prevents heat exchanger from being covered in snow. 2. Prevents snow accumulating inside the air duct.
Base heater	—	Needed	Outdoor units equipped with a heater for cold regions are those with an "H" in the model name. For the cold-climate zone, use of a unit with a heater is strongly recommended. Even for the moderate-climate zone use of a unit with a heater is recommended for regions subject to high humidity in winter.

⚠ CAUTION About disposal of drainage water

When the unit is installed in cold or snowy regions :

Drainage water may freeze in the drain socket/hose and prevent the fan from rotating.



Do not attach a drain socket packaged as an accessory to the unit.

* In the case that fitting a drain socket is absolutely necessary, steps must be taken so that the drainage water does not freeze. For more information, please consult Mitsubishi Electric or one of its dealers/resellers.

Mr.SLIM+

A Smart Air Conditioning and Hot Water Supply System Conceived from Eco-conscious Ideas

Mr. SLIM+ has a heat recovery function, which uses waste heat from air conditioners to heat water. Thanks to heat recovery, the Mr. SLIM+ model can achieve a COP of 7.0*, resulting in intelligent systems with amazing efficiency.

*Conditions for air-to-air cooling: Indoor 27°C (dry bulb), 19°C (wet bulb); Outdoor 35°C (dry bulb)

1 Unit, 2 Roles – Total Comfort Year-round

Air Conditioning and Hot Water Supply Matching the Needs of Each Room

All-in-one outdoor unit (air conditioning, domestic hot water supply and hot water heating)

Mr. SLIM for Air-to-Air

Mr. SLIM+ utilises a duct system that enables the air conditioning or heating of multiple rooms, and other indoor unit type systems that it is possible to fit to various applications.

ecodan for Air-to-Water

- ✓Domestic hot water (DHW) supply
- ✓Heating for multiple rooms



Various Operations

Mr. SLIM / ATA (Air Cooling)

Cooling using ATA indoor unit

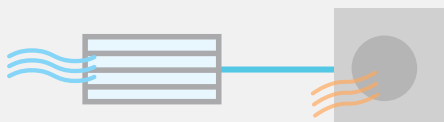

Mr. SLIM / ATA (Air Heating)

Heating using ATA indoor unit



ecodan / ATW (Hot water heating + DHW)

Heating and DHW using ATW indoor unit

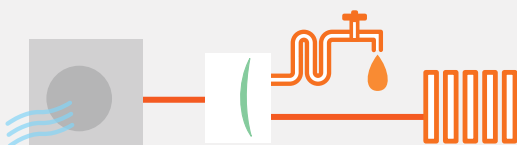

Mr. SLIM + ecodan / ATA (Air Cooling) + DHW

Heat recovery using both ATA and ATW indoor units

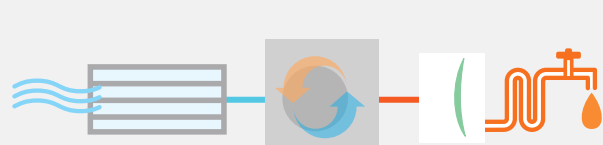

Specifications

Indoor unit				PLA-ZM71EA	PKA-M71KAL	PCA-M71KA	PSA-RP71KA	PEAD-M71JA	PEAD-M71JAL	
Outdoor unit				PUHZ-FRP71VHA2	PUHZ-FRP71VHA2	PUHZ-FRP71VHA2	PUHZ-FRP71VHA2	PUHZ-FRP71VHA2	PUHZ-FRP71VHA2	
Refrigerant				R410A*1						
Power supply		Outdoor (V / Phase / Hz)		230 / Single / 50						
Air-to-Air (ATA)	Cooling	Capacity	Rated	kW	7.1	7.1	7.1	7.1	7.1	7.1
			Min-Max	kW	3.3-8.1	3.3-8.1	3.3-8.1	3.3-8.1	3.3-8.1	3.3-8.1
		Total input	Rated	kW	1.88	1.93	1.93	2.15	2.10	2.04
			EER		3.77	3.67	3.67	3.30	3.38	3.48
		Design load		kW	7.1	7.1	7.1	7.1	7.1	7.1
		Annual electricity consumption *2		kWh/a	376	386	384	409	444	427
		SEER *4			6.6	6.4	6.4	6.0	5.5	5.8
		Energy-efficiency class			A++	A++	A++	A+	A	A+
	Heating (average season)	Capacity	Rated	kW	8.0	8.0	8.0	8.0	8.0	8.0
			Min-Max	kW	3.5-10.2	3.5-10.2	3.5-10.2	3.5-10.2	3.5-10.2	3.5-10.2
		Total input	Rated	kW	2.11	2.29	2.29	2.42	2.11	2.11
			COP		3.80	3.50	3.50	3.30	3.79	3.79
		Design load		kW	4.7	4.7	4.7	4.7	4.9	4.9
		Declared capacity	at reference design temperature	kW	4.7 (-10°C)	4.7 (-10°C)	4.7 (-10°C)	4.7 (-10°C)	4.9 (-10°C)	4.9 (-10°C)
			at bivalent temperature	kW	4.7 (-10°C)	4.7 (-10°C)	4.7 (-10°C)	4.7 (-10°C)	4.9 (-10°C)	4.9 (-10°C)
			at operation limit temperature	kW	3.5 (-20°C)	3.5 (-20°C)	3.5 (-20°C)	3.5 (-20°C)	3.7 (-20°C)	3.7 (-20°C)
		Back-up heating capacity		kW	0	0	0	0	0	0
		Annual electricity consumption *2		kWh/a	1,509	1,564	1,556	1,699	1,791	1,791
		SCOP *4			4.3	4.2	4.2	3.8	3.8	3.8
		Energy-efficiency class			A+	A+	A+	A	A	A
Air-to-Water (ATW)	Nominal flow rate (for heating)			L/min	22.90					
	Heating*5	A7W35	Capacity	kW	8.00	8.00	8.00	8.00	8.00	8.00
			Input	kW	1.98	1.98	1.98	1.98	1.98	1.98
			COP		4.05	4.05	4.05	4.05	4.05	4.05
		A2W35	Capacity	kW	7.50	7.50	7.50	7.50	7.50	7.50
			Input	kW	2.67	2.67	2.67	2.67	2.67	2.67
			COP		2.81	2.81	2.81	2.81	2.81	2.81
	Heat recovery (ATA cooling & ATW)*6	W45	Capacity (ATA cooling + ATW)	kW	7.1+8.0	7.1+8.0	7.1+8.0	7.1+8.0	7.1+8.0	7.1+8.0
			Input	kW	1.90	1.93	1.95	2.02	2.15	2.13
			COP		7.95	7.82	7.74	7.48	7.02	7.09
		W55	Capacity (ATA cooling + ATW)	kW	7.1+9.0	7.1+9.0	7.1+9.0	7.1+9.0	7.1+9.0	7.1+9.0
			Input	kW	2.97	3.00	3.02	3.09	3.22	3.20
			COP		5.42	5.37	5.33	5.21	5.00	5.03
	ATW indoor unit				Cylinder unit or Hydro box (see previous page)					
	Outdoor unit	Dimensions	HxWxD	mm	943-950-330 (+30)					
Weight			kg	73	73	73	73	73	73	
		Air volume	Cooling	m ³ /min	50	50	50	50	50	50
		Heating	m ³ /min	50	50	50	50	50	50	
Sound pressure level (SPL)		Cooling	dB(A)	47	47	47	47	47	47	
		Heat recovery	dB(A)	47	47	47	47	47	47	
		ATA Heating	dB(A)	49	49	49	49	49	49	
		ATW Heating	dB(A)	49	49	49	49	49	49	
		Sound power level (PWL)	Cooling	dB(A)	67	67	67	67	67	67
		Heat recovery	dB(A)	67	67	67	67	67	67	
		ATA Heating	dB(A)	68	68	68	68	68	68	
		ATW Heating	dB(A)	68	68	68	68	68	68	
Operating current (max)		A	19.0	19.0	19.0	19.0	19.0	19.0		
Breaker size		A	25	25	25	25	25	25		
Ext.piping	Diameter	Liquid/Gas	mm	9.52/15.88	9.52/15.88	9.52/15.88	9.52/15.88	9.52/15.88	9.52/15.88	
	Max. length	Out-In	m	30 (for ATA) + 30 (for ATW)						
	Max. height	Out-In	m	20	20	20	20	20	20	
Guaranteed operating range (outdoor)	Cooling *3	°C	-15~+46	-15~+46	-15~+46	-15~+46	-15~+46	-15~+46	-15~+46	
	Heating	°C	-20~+21	-20~+21	-20~+21	-20~+21	-20~+21	-20~+21	-20~+21	
	ATW	°C	-20~+35	-20~+35	-20~+35	-20~+35	-20~+35	-20~+35	-20~+35	
	Heat recovery	°C	+7~+46	+7~+46	+7~+46	+7~+46	+7~+46	+7~+46	+7~+46	

*1 Refrigerant leakage contributes to climate change. Refrigerant with lower global warming potential (GWP) would contribute less to global warming than a refrigerant with higher GWP, if leaked to the atmosphere. This appliance contains a refrigerant fluid with a GWP equal to 1975. This means that if 1 kg of this refrigerant fluid would be leaked to the atmosphere, the impact on global warming would be 1975 times higher than 1 kg of CO₂, over a period of 100 years. Never try to interfere with the refrigerant circuit yourself or disassemble the product yourself and always ask a professional. The GWP of R410A is 2088 in the IPCC 4th Assessment Report.

*2 Energy consumption based on standard test results. Actual energy consumption will depend on how the appliance is used and where it is located.

*3 Optional air protection guide is required where ambient temperature is lower than -5°C.

*4 SEER/SCOP values are measured based on EN14825.

*5 Air-to-Water values are measured based on EN14511 (Circulation pump input is not included).

*6 Conditions for Air-to-Air cooling: Indoor 27°C (dry bulb) /19°C (wet bulb); Outdoor 35°C (dry bulb).

PUMY+ecodan

Air-to-Air and Air-to-Water Hybrid Multi Split System

1 Unit, 2 Roles – Total Comfort Year-round

Air Conditioning and Hot Water Supply Matching the Needs of Each Room

All-in-one outdoor unit (air conditioning, domestic hot water supply and hot water heating)

PUMY for Air-to-Air

PUMY utilises various indoor units, enabling the air conditioning or heating of multiple rooms, and controls each unit individually.

ecodan for Air-to-Water

- ✓Domestic hot water (DHW) supply
- ✓Heating for multiple rooms

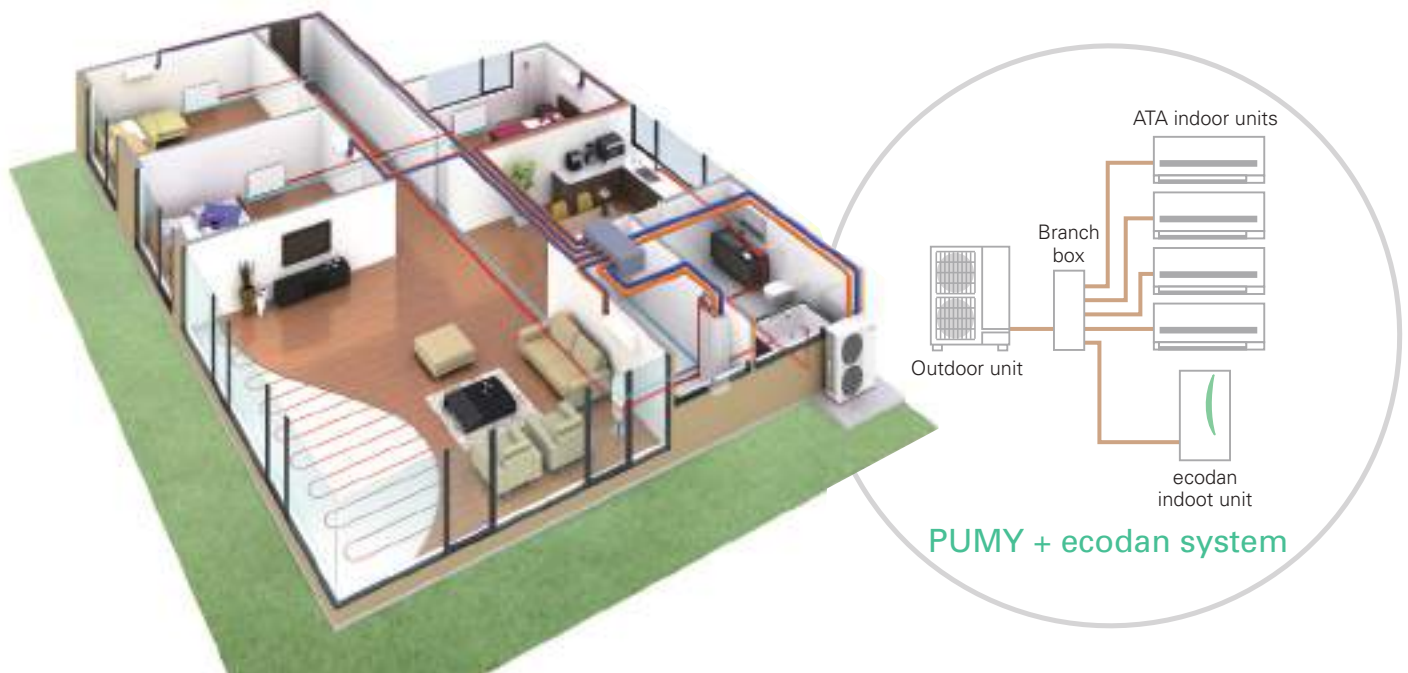

Main Operation Patterns

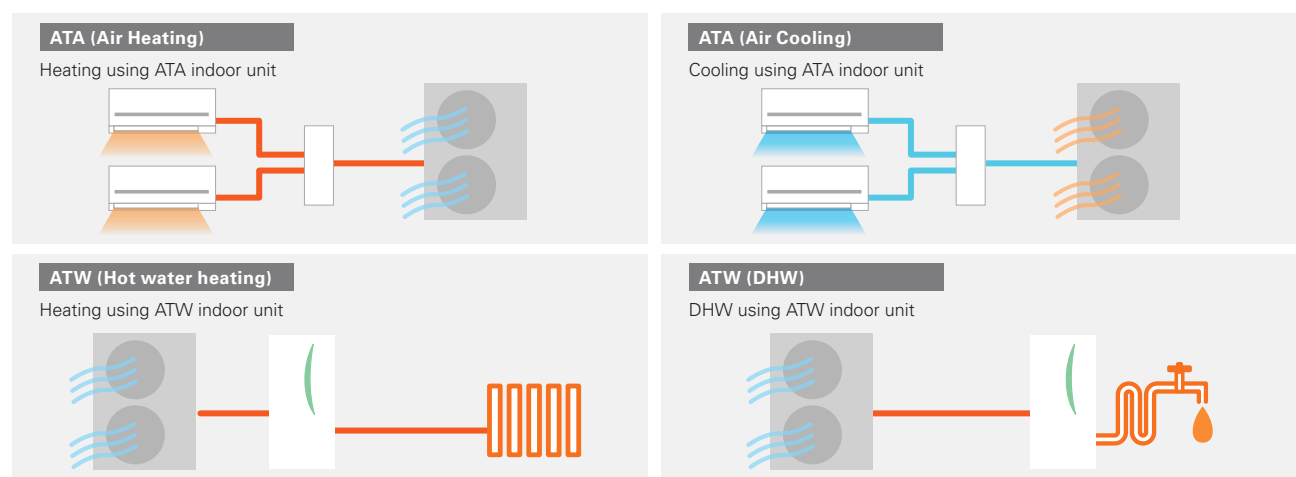

Optional Operation Patterns* (simultaneous)



*When using optional simultaneous operation, there are some restrictions, such as connectable indoor units, operation range and DHW flow temp.

Usage Pattern All-in-one System Solution

Summer 2-in-1 Operation

In summer ATA cooling and DHW are utilised. Keep your room comfortable with ATA cooling during high temperature daytime. Heat pump operates to heat up water stored in the DHW tank when ATA is not operated. The hot water can be utilised for shower and washing dishes during daytime.

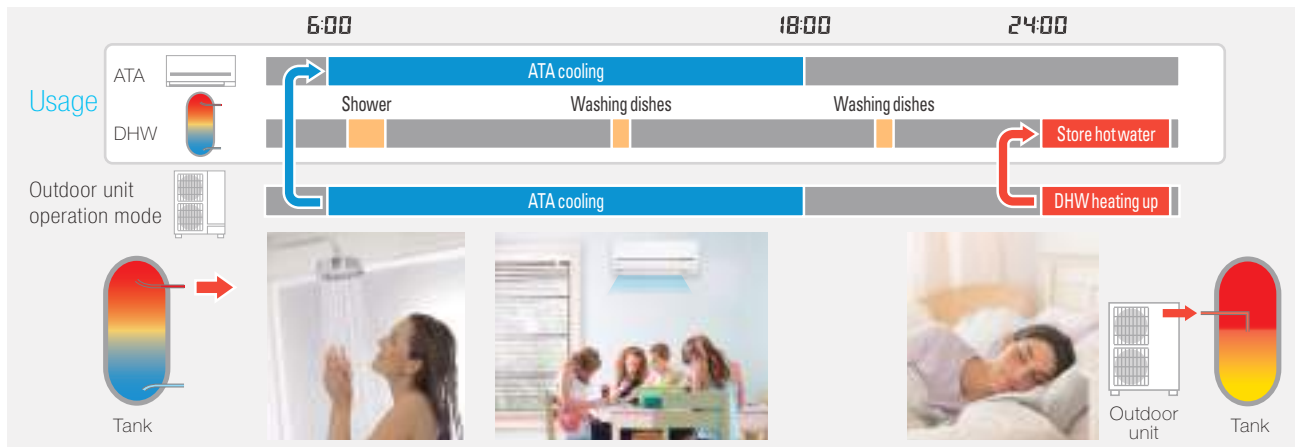

Spring & Autumn 2-in-1 Operation

In spring and autumn, ATA heating and DHW are utilised. ATA heating can warm up each room quickly during the low temperature morning and evening. Heat pump operates to heat up water stored in the DHW tank when ATA is not operated. The hot water can be utilised for shower and washing dishes during daytime.

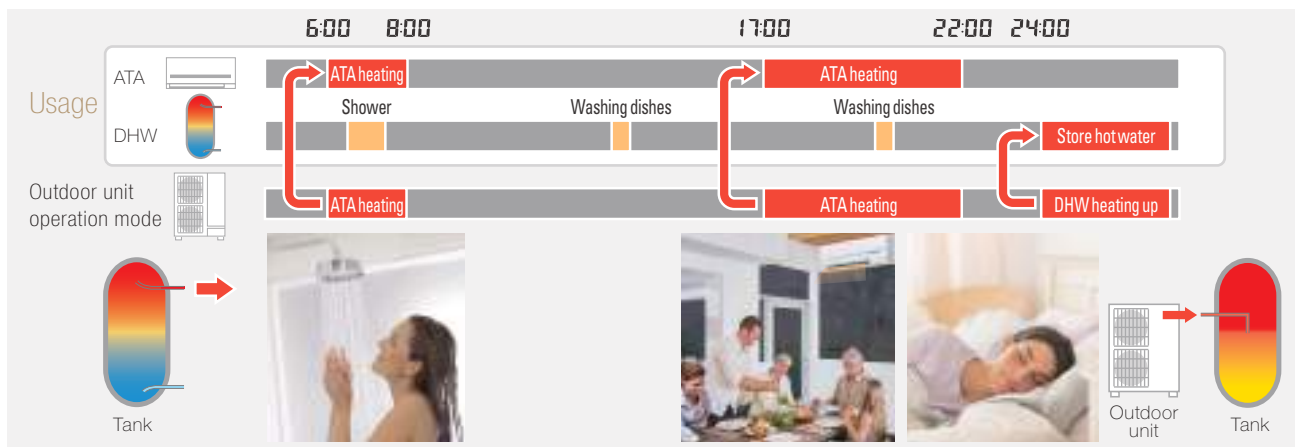

Winter ecodan

In winter ATW heating and DHW are utilised. ATW heating warms home all the day in severe cold weather. ATW heating stops temporarily only when the heat pump operates to heat up water stored in the DHW tank.

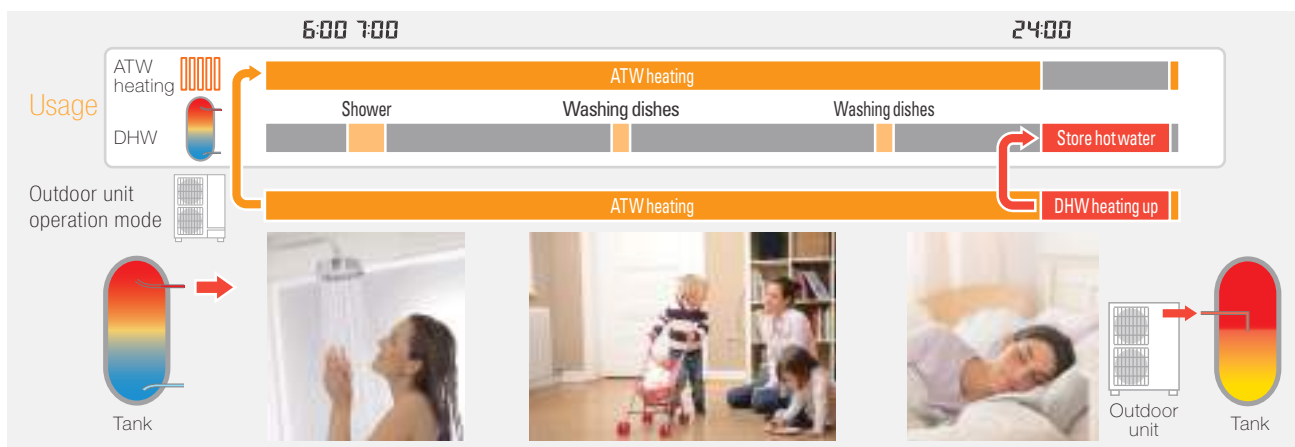

Model name				PUMY- P112VKM5(-BS)	PUMY- P125VKM5(-BS)	PUMY- P140VKM5(-BS)	PUMY- P112YKME4(-BS)	PUMY- P125YKME4(-BS)	PUMY- P140YKME4(-BS)	
Power supply				1-phase 220 - 230 - 240V, 50Hz			3-phase 380 - 400 - 415V, 50Hz			
Air-to-Air (ATA)	Cooling (nominal)*1	Capacity	kW	12.5	14.0	15.5	12.5	14.0	15.5	
		Power input	kW	2.79	3.46	4.52	2.79	3.46	4.52	
		EER		4.48	4.05	3.43	4.48	4.05	3.43	
	Temp. range of cooling	Indoor temp.	W.B.	15 - 24°C						
		Outdoor temp.*2	D.B.	-5 - 52°C						
	Heating (nominal)*1	Capacity	kW	14.0	16.0	18.0	14.0	16.0	18.0	
		Power input	kW	3.04	3.74	4.47	3.04	3.74	4.47	
		COP		4.61	4.28	4.03	4.61	4.28	4.03	
Temp. range of heating	Indoor temp.	W.B.	15 - 27°C							
	Outdoor temp.	D.B.	-20 - 15°C							
Air-to-Water (ATW)	Nominal flow rate (for heating)			L/min	35.8					
	Heating*3	A7W35	Capacity	kW	12.5					
			Power input	kW	3.06					
			COP		4.08					
	A2W35	Capacity	kW	10.0						
		Power input	kW	3.50						
		COP		2.86						
	Guaranteed operating range	ATW	Heating	D.B.	-20 - +21°C					
			DHW	D.B.	-20 - +35°C					
			ATA heating + DHW	D.B.	7 - +21°C					
	ATA + ATW	ATA heating + ATW heating *4	D.B.	-10 - +21°C						
		Maximum Outlet water temp.			°C	55				
Outdoor unit	Indoor unit connectable	ATA only	Total capacity		50 to 130% of outdoor unit capacity					
			Model/ Quantity	Branch box system	15-100/8	15-100/8	15-100/8	15-100/8	15-100/8	15-100/8
		ATA + ATW individual operation	Total capacity		ATA : Max 130% of outdoor unit capacity + ATW (EHST20C or EHSC) *7					
	Model/Quantity (including ATW)		Branch box system	15-100/8	15-100/8	15-100/8	15-100/8	15-100/8	15-100/8	
	ATA + ATW simultaneous operation	Total capacity		Max 100% of outdoor unit capacity : ATA + ATW (EHST20C or EHSC) *7						
		Model/Quantity	ATA*12	15/1*8	15-25/2*9	15-42*11/3*10	15/1*8	15-25/2*9	15-42*11/3*10	
			ATW	ATW (EHST20C or EHSC) / 1						
	Sound pressure level (measured in anechoic room)			dB<A>	49 / 51	50 / 52	51 / 53	49 / 51	50 / 52	51 / 53
	Sound power level (measured in anechoic room)			dB<A>	69 / 71	70 / 72	71 / 73	69 / 71	70 / 72	71 / 73
	Refrigerant piping diameter			Liquid pipe	9.52 flare					
				Gas pipe	15.88 flare					
	Fan	Type x Quantity		Propeller fan x 2						
		Airflow rate		m³/min	110					
				L/s	1,883					
				cfm	3,884					
Compressor	Motor output		0.074 + 0.074							
	Type x Quantity		Scroll hermetic compressor x 1							
	Starting method		Inverter							
Motor output			kW	2.9	3.5	3.9	2.9	3.5	3.9	
External dimensions (H x W x D)			mm	1,338 x 1,050 x 330 (+40)						
Weight			kg	122			YKM: 125 / YKME: 136			

*1

	Indoor	Outdoor	Piping length	Level difference
Cooling	27°C DB / 19°C WB	35°C DB	7.5m	0m
Heating	20°C DB	7°C DB / 6°C WB	7.5m	0m

*2 10 to 52°C D.B.: When connecting PKFY-P15/20/25VBM, PFFY-P20/25/32VKM, PFFY-P20/25/32VLE(R)M, PEFY-P*VMA3 or M, S and P series indoor unit.

*3 In the case of ATW single connection. Input to circulation pump is not included.

*4 In the case of simultaneous operation of ATA heating and ATW heating, target flow temperature range is restricted to 45-55°C and when the ambient temp is under 7°C, the flow temp is lowered.

*5 Up to P100 when connecting via branch box.

*6 Up to 11 units when connecting via 2 branch boxes.

*7 Only one ecodan unit can be connected.

*8 Exceptionally, one MSZ-SF15VA or MSZ-AP15VF can be connected.

*9 Exceptionally, two MSZ-SF15VA or MSZ-AP15VF can be connected.

*10 Exceptionally, three MSZ-SF15VA or MSZ-AP15VF can be connected.

*11 In the case of City Multi connection, maximum is P32.

*12 PKFY and PFFY series are not connectable.

Piping specifications

Total piping length	m	150*	a+b+c+d+e+f
Farthest piping length	m	80	a+b+d or a+c+e
		85	a+f
Total piping length between outdoor unit and branch box	m	55	a+b+c
Total piping length between branch boxes and indoor units	m	95	d+e
Farthest piping length from the first joint	m	30	b or c or f
Farthest piping length after branch box	m	25	d or e
Height difference (Outdoor upside / Outdoor downside)	m	50 / 40	

*When an ecodan is connected, the maximum piping length is 150m.

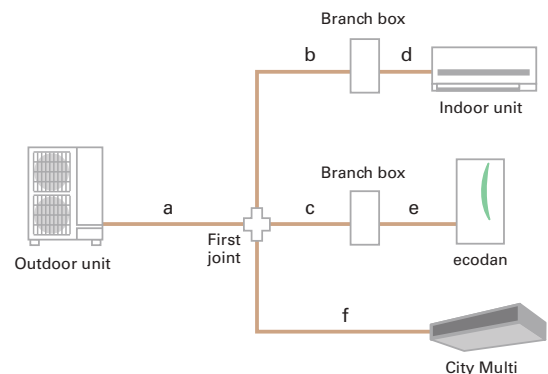

PUMY+ ecodan Compatibility Table

ATW branch box connection compatibility table

Series	Type	Model name	Compatibility	Type	Model name	Compatibility	Type	Model name	Compatibility
ATW	Cylinder unit	EHST20C-VM2/6D	●	Hydro box	EHSC-VM2/6D	●	Branch box	PAC-MK53BC	●
		EHST20C-YM9D	●		EHSC-YM9D	●		PAC-MK33BC	●

Connectable indoor unit capacity

For individual operation ATA+ATW (no simultaneous operation) ATA: Max 130% of outdoor unit capacity + ATW (EHST20C or EHSC)

Outdoor capacity 12.5kW	ATW indoor unit (Cylinder or Hydro box) 11.2kW	Connectable ATA indoor unit total capacity: Max.16.2kW (130%)
Outdoor capacity 14.0kW	ATW indoor unit (Cylinder or Hydro box) 11.2kW	Connectable ATA indoor unit total capacity: Max.18.2kW (130%)
Outdoor capacity 15.5kW	ATW indoor unit (Cylinder or Hydro box) 11.2kW	Connectable ATA indoor unit total capacity: Max.20.2kW (130%)

For simultaneous operation of ATA+ATW Max 100% of outdoor unit capacity: ATA + ATW (EHST20C or EHSC)

Outdoor capacity 12.5kW	ATW indoor unit (Cylinder or Hydro box) 11.2kW	ATA capacity Max. 1.3kW	*Exceptionally, one MSZ-SF15VA or MSZ-AP15VF can be connected.
Outdoor capacity 14.0kW	ATW indoor unit (Cylinder or Hydro box) 11.2kW	ATA capacity Max. 2.8kW	*Exceptionally, two units of MSZ-SF15VA or MSZ-AP15VF can be connected.
Outdoor capacity 15.5kW	ATW indoor unit (Cylinder or Hydro box) 11.2kW	ATA capacity Max. 4.3kW	*Exceptionally, three units of MSZ-SF15VA or MSZ-AP15VF can be connected.

Split Type Specifications

Indoor unit

<Cylinder unit (Heating only)>

Model name			Small capacity				
			EHST17D-VM2D	EHST20D-VM2D	EHST20D-YM9D	EHST30D-YM9ED	
Type			Heating only				
Expansion vessel			✓	✓	✓	—	
Booster heater (2/6/9 kW)			✓	✓	✓	✓	
Dimensions	HxWxD	mm	1400x595x680	1600x595x680	2050x595x680		
Weight (empty)		kg	93	99	102	117	
Control Board Power supply (Phase / V / Hz)			~ /N, 230V, 50Hz	~ /N, 230V, 50Hz	~ /N, 230V, 50Hz	~ /N, 230V, 50Hz	
Heater	Booster heater	Power supply (Phase / V / Hz)	~ /N, 230V, 50Hz	~ /N, 230V, 50Hz	3 ~ /N, 230V, 50Hz	3 ~ /N, 230V, 50Hz	
		Capacity	kW	2	2	3+6	3+6
		Current	A	9	9	13	13
		Breaker size	A	16	16	16	16
Domestic hot water tank	Volume / Material	L / -	170 / Stainless steel	200 / Stainless steel	300 / Stainless steel		
Guaranteed operating range *1	Ambient	°C	0 - 35 (≤80%RH)				
	Outdoor	Heating	°C	See outdoor unit spec table			
		Cooling	°C	—			
Target temperature range	Heating	Room temperature	°C				10 - 30
		Flow temperature	°C				20 - 60
	Cooling	Room temperature	°C				—
		Flow temperature	°C				—
DHW tank performance	Max. hot water temperature	°C	70				
	Water heater energy efficiency class		A+		A - A+		
Sound pressure level (PWL)			dB (A)				41

*1 The indoor environment must be frost-free

*2 For the model without booster heater and immersion heater, the maximum allowable hot water temperature is 3°C lower than maximum outlet water of outdoor unit. For the maximum outlet water of outdoor unit, refer to outdoor unit data book.

<Cylinder unit (Heating only)>

Model name			Medium capacity					
			EHST20C-VM2D	EHST20C-VM6D	EHST20C-YM9D	EHST30C-VM6ED	EHST30C-YM9ED	
Type			Heating only					
Expansion vessel			✓	✓	✓	—	—	
Booster heater (2/6/9 kW)			✓	✓	✓	✓	✓	
Dimensions	HxWxD	mm	1600x595x680			2050x595x680		
Weight (empty)		kg	110	110	112	122	124	
Control Board Power supply (Phase / V / Hz)			~ /N, 230V, 50Hz	~ /N, 230V, 50Hz	~ /N, 230V, 50Hz	~ /N, 230V, 50Hz	~ /N, 230V, 50Hz	
Heater	Booster heater	Power supply (Phase / V / Hz)	~ /N, 230V, 50Hz	~ /N, 230V, 50Hz	3 ~ /N, 230V, 50Hz	~ /N, 230V, 50Hz	3 ~ /N, 230V, 50Hz	
		Capacity	kW	2	2+4	3+6	2+4	3+6
		Current	A	9	26	13	26	13
		Breaker size	A	16	32	16	32	16
Domestic hot water tank	Volume / Material	L / -	200 / Stainless steel			300 / Stainless steel		
Guaranteed operating range *1	Ambient	°C	0 - 35 (≤80%RH)					
	Outdoor	Heating	°C	See outdoor unit spec table				
		Cooling	°C	—				
Target temperature range	Heating	Room temperature	°C					10 - 30
		Flow temperature	°C					20 - 60
	Cooling	Room temperature	°C					—
		Flow temperature	°C					—
DHW tank performance	Max. hot water temperature	°C	70					
	Water heater energy efficiency class		A+		A			
Sound pressure level (PWL)			dB (A)					40

*1 The indoor environment must be frost-free

*2 For the model without booster heater and immersion heater, the maximum allowable hot water temperature is 3°C lower than maximum outlet water of outdoor unit. For the maximum outlet water of outdoor unit, refer to outdoor unit data book.

<Hydro box (Heating only)>

Model name			Small capacity		Medium capacity			Large capacity	
			EHSD-VM2D	EHSD-YM9D	EHSC-VM2D	EHSC-VM6D	EHSC-YM9D	EHSE-YM9ED	
Type			Heating only						
Expansion vessel			✓	✓	✓	✓	✓	—	
Booster heater (2/6/9 kW)			✓	✓	✓	✓	✓	✓	
Dimensions	HxWxD	mm	800x530x360					950x600x360	
Weight (empty)		kg	43	44	47	48	48	63	
Control Board Power supply (Phase / V / Hz)			~ /N, 230V, 50Hz	~ /N, 230V, 50Hz	~ /N, 230V, 50Hz	~ /N, 230V, 50Hz	~ /N, 230V, 50Hz	~ /N, 230V, 50Hz	
Heater	Booster heater	Power supply (V / Phase / Hz)	~ /N, 230V, 50Hz	3 ~ /N, 230V, 50Hz	~ /N, 230V, 50Hz	~ /N, 230V, 50Hz	3 ~ /N, 230V, 50Hz	3 ~ /N, 230V, 50Hz	
		Capacity	kW	2	3+6	2	2+4	3+6	3+6
		Current	A	9	13	9	26	13	13
		Breaker size	A	16	16	16	32	16	16
Guaranteed operating range *1	Ambient	L / -	0 - 35 (≤80%RH)						
	Outdoor	Heating	°C	See outdoor unit spec table					
		Cooling	°C	—					
Target temperature range	Heating	Room temperature	°C						10 - 30
		Flow temperature	°C						20 - 60
	Cooling	Room temperature	°C						—
		Flow temperature	°C						—
Sound pressure level (PWL)			dB (A)		41	40		45	

*1 The indoor environment must be frost-free.

Split Type Specifications

Indoor unit

<Cylinder unit (Reversible)>

			Small capacity			
Model name			ERST17D-VM2D	ERST20D-VM2D	ERST30D-VM2ED	
Type			Heating and Cooling			
Expansion vessel			✓	✓		
Booster heater (2/6/9kW)			✓	✓	✓	
Dimensions	HxWxD	mm	1400x595x680	1600x595x680	2050x595x680	
Weight (empty)		kg	94	100	115	
Control Board Power supply (Phase / V / Hz)			~/N, 230V, 50Hz	~/N, 230V, 50Hz	~/N, 230V, 50Hz	
Heater	Booster heater	Power supply (V / Phase / Hz)	~/N, 230V, 50Hz	~/N, 230V, 50Hz	~/N, 230V, 50Hz	
		Capacity	kW	2	2	2
		Current	A	9	9	9
		Breaker size	A	16	16	16
Domestic hot water tank	Volume / Material	L / -	170 / Stainless steel	200 / Stainless steel	300 / Stainless steel	
Guaranteed operating range *1	Ambient	°C	0 - 35 (≤ 80%RH)			
	Outdoor	Heating	°C	See outdoor unit spec table		
		Cooling	°C	See outdoor unit spec table *2		
Target temperature range	Heating	Room temperature	°C 10 - 30			
		Flow temperature	°C 20 - 60			
	Cooling	Room temperature	°C -			
		Flow temperature	°C 5 - 25			
DHW tank performance	Max. hot water temperature	°C	70			
	Water heater energy efficiency class		A ⁺		A - A ⁺	
Sound pressure level (PWL)			dB (A) 41			

*1 The indoor environment must be frost-free.

*2 During cooling operation at low outdoor temperature (10°C or lower), frozen water may cause damage on plate heat exchanger.

<Cylinder unit (Reversible)>

			Medium capacity		
Model name			ERST20C-VM2D	ERST30C-VM2ED	
Type			Heating and Cooling		
Expansion vessel			✓	✓	
Booster heater (2/6/9kW)			✓	✓	
Dimensions	HxWxD	mm	1600x595x680	2050x595x680	
Weight (empty)		kg	110	122	
Control Board Power supply (Phase / V / Hz)			~/N, 230V, 50Hz	~/N, 230V, 50Hz	
Heater	Booster heater	Power supply (V / Phase / Hz)	~/N, 230V, 50Hz	~/N, 230V, 50Hz	
		Capacity	kW	2	2
		Current	A	9	9
		Breaker size	A	16	16
Domestic hot water tank	Volume / Material	L / -	200 / Stainless steel	300 / Stainless steel	
Guaranteed operating range *1	Ambient	°C	0 - 35 (≤ 80%RH)		
	Outdoor	Heating	°C See outdoor unit spec table		
		Cooling	°C See outdoor unit spec table *2		
Target temperature range	Heating	Room temperature	°C 10 - 30		
		Flow temperature	°C 20 - 60		
	Cooling	Room temperature	°C -		
		Flow temperature	°C 5 - 25		
DHW tank performance	Max. hot water temperature	°C	70		
	Water heater energy efficiency class		A ⁺	A	
Sound pressure level (PWL)			dB (A) 40		

*1 The indoor environment must be frost-free.

*2 During cooling operation at low outdoor temperature (10°C or lower), frozen water may cause damage on plate heat exchanger.

<Hydro box (Reversible)>

			Small capacity	Medium capacity	Large capacity		
Model name			ERSD-VM2D	ERSC-VM2D	ERSE-MED	ERSE-VM9ED	
Type			Heating and Cooling				
Expansion vessel			✓	✓	-	-	
Booster heater (2/6/9kW)			✓	✓	-	✓	
Dimensions	HxWxD	mm	800x530x360		950x600x360		
Weight (empty)		kg	44	48	62	64	
Control Board Power supply (Phase / V / Hz)			~/N, 230V, 50Hz	~/N, 230V, 50Hz	~/N, 230V, 50Hz	~/N, 230V, 50Hz	
Heater	Booster heater	Power supply (V / Phase / Hz)	~/N, 230V, 50Hz	~/N, 230V, 50Hz	-	3~400V, 50Hz	
		Capacity	kW	2	2	-	3+6
		Current	A	9	9	-	13
		Breaker size	A	16	16	-	16
Guaranteed operating range *1	Ambient	°C	0 - 35 (≤ 80%RH)				
	Outdoor	Heating	°C See outdoor unit spec table				
		Cooling	°C See outdoor unit spec table *2				
Target temperature range	Heating	Room temperature	°C 10 - 30				
		Flow temperature	°C 20 - 60				
	Cooling	Room temperature	°C -				
		Flow temperature	°C 5 - 25				
Sound pressure level (PWL)			dB (A) 41	40	45		

*1 The indoor environment must be frost-free.

*2 If you use our system in cooling mode at the low ambient temperature (10°C or below), there are some risks of plate heat exchanger breaking by frozen water.

Split Type Specifications

Outdoor unit

				Eco Inverter		
Model name				SUZ-SWM40VA	SUZ-SWM60VA	SUZ-SWM80VA
Refrigerant				R32*1		
Dimensions		HxWxD	mm	880x840x330	880x840x330	880x840x330
Weight			kg	54	54	54
Power supply (V / Phase / Hz)				230 / 1-ph / 50	230 / 1-ph / 50	230 / 1-ph / 50
Heating	A7W35*2	Nominal	kW	4.0	6.0	7.5
		COP		5.20	4.86	4.70
	A2W35*2	Nominal	kW	4.0	5.0	6.5
		COP		3.90	3.33	3.40
Average climate water outlet 35°C*3		Class	A+++	A+++	A+++	
		ηs	180	181	182	
Average climate water outlet 55°C*3		Class	A++	A++	A++	
		ηs	129	130	131	
DHW 200L(L) Load Profile (Average climate)*4		Class	A+	A+	A+	
		ηwh	159	148	148	
Max outlet water temperature (°C)				60	60	60
Cooling	A35W7*2	Nominal	kW	4.5	5.0	5.4
		EER		3.29	3.03	3.00
	A35W18*2	Nominal	kW	5.6	6.0	6.3
		EER		4.97	4.88	4.80
PWL (Heating)*5			dB(A)	58	60	62
Max operating current				A	13.9	13.9
Breaker size				A	16	16
Piping	Diameter	Liquid/Gas	mm	6.35 / 12.7	6.35 / 12.7	6.35 / 12.7
	Length	Out-In	m	5-30	5-30	5-30
	Height	Out-In	m	Max 30	Max 30	Max 30
Guaranteed Operating Range	Heating		°C	-20°C-24°C	-20°C-24°C	-20°C-24°C
	DHW		°C	-20°C-35°C	-20°C-35°C	-20°C-35°C
	Cooling		°C	10°C-46°C	10°C-46°C	10°C-46°C

Outdoor unit

				Power Inverter, Heating only			ZUBADAN, Heating only				
Model name				PUD-SWM80V/YAA	PUD-SWM100V/YAA	PUD-SWM120V/YAA	PUD-SHWM80V/YAA	PUD-SHWM100V/YAA	PUD-SHWM120V/YAA	PUD-SHWM140V/YAA	
Refrigerant				R32*1							
Dimensions		HxWxD	mm	1020x1050x480	1020x1050x480	1020x1050x480	1020x1050x480	1020x1050x480	1020x1050x480		
Weight			kg	101/114	105/118	105/118	102/115	108/121	108/121	110/122	
Power supply (V / Phase / Hz)				VAA: 230 / 1-ph / 50, YAA: 400 / 3-ph / 50							
Heating	A7W35*2	Nominal	kW	6.0	8.0	10.0	6.0	8.0	10.0	12.0	
		COP		4.76	5.00	4.70	5.03	5.00	4.80	4.70	
	A2W35*2	Nominal	kW	8.0	10.0	12.0	8.0	10.0	12.0	14.0	
		COP		3.55	3.30	3.24	3.75	3.45	3.30	3.05	
Average climate water outlet 35°C*3		Class	A+++	A+++	A+++	A+++	A+++	A+++	A+++		
		ηs	178/176	178/177	177/176	181/179	180/178	179/177	179/177		
Average climate water outlet 55°C*3		Class	A++	A++	A++	A++	A++	A++	A++		
		ηs	131/130	131/130	129/128	135/134	136/135	135/134	134/134		
DHW 200L(L)/300L(XL) Load Profile (Average climate)*4		Class	A+ / A	A+ / A	A+ / A	A+ / A	A+ / A	A+ / A	A+ / A		
		ηwh	148/121	148/121	148/121	148/121	148/121	148/121	145/121		
Max outlet water temperature (°C)				60	60	60	60	60	60		
PWL (Heating)*5			dB(A)	56	59	60	56	59	60	62	
Max operating current				A	22/8	26/10	28/12	22/8	26/10	28/12	35/12
Breaker size				A	25/16	30/16	32/16	25/16	30/16	32/16	40/16
Piping	Diameter	Liquid/Gas	mm	6.35/12.7	6.35/12.7	6.35/12.7	6.35/12.7	6.35/12.7	6.35/12.7	6.35/12.7	
	Length	Out-In	m	2 - 30	2 - 30	2 - 30	2 - 30	2 - 30	2 - 30	2 - 25	
	Height	Out-In	m	Max. 30	Max. 30	Max. 30	Max. 30	Max. 30	Max. 30	Max. 25	
Guaranteed Operating Range	Heating		°C	-25°C-24°C	-25°C-24°C	-25°C-24°C	-28°C-24°C	-28°C-24°C	-28°C-24°C	-28°C-24°C	
	DHW		°C	-25°C-35°C	-25°C-35°C	-25°C-35°C	-28°C-35°C	-28°C-35°C	-28°C-35°C	-28°C-35°C	

*1 Refrigerant leakage contribute to climate change. Refrigerant with lower global warming potential (GWP) would contribute less to global warming than a refrigerant with higher GWP, if leaked to the atmosphere. This appliance contains a refrigerant fluid with a GWP equal to 550. This means that if 1 kg of this refrigerant fluid would be leaked to the atmosphere, the impact on global warming would be 550 times higher than 1 kg of CO₂, over a period of 100 years. Never try to interfere with the refrigerant circuit yourself or disassemble the product yourself and always ask a professional. The GWP of R32 is 675 in the IPCC 4th Assessment Report.

*2 Air-to-Water values are measured based on EN14511 (Circulation pump input is not included.).

*3 ηs values are measured based on EN14825. *4 ηwh values are measured based on EN16147. *5 Sound power levels are measured based on EN12102.

Split type	Small capacity (Under 5kW)*	Medium capacity (8.0kW-14kW)*
		 PUD-SHWM80/100/120/140
		 PUD-SWM80/100/120
Eco Inverter	 SUZ-SWM40/60	 SUZ-SWM60

*Rated capacity is at conditions A2W35. (according to EN14511)

R410A

Split Type Specifications

Outdoor unit



Model name				Power Inverter					
				PUHZ-SW75V/YAA(-BS)	PUHZ-SW100V/YAA(-BS)	PUHZ-SW120V/YHA(-BS)	PUHZ-SW160YKA(-BS)	PUHZ-SW200YKA(-BS)	
Refrigerant				R410A*1					
Dimensions		HxWxD	mm	1020x1050x480	1020x1050x480	1350x950x330	1338x1050x330	1338x1050x330	
Weight		kg		92/104	114/126	118/130	136	136	
Power supply (V / Phase / Hz)				VAA, VHA: 230 / 1-ph / 50, YAA, YHA, YKA: 400 / 3-ph / 50					
Heating	A7W35*2	Nominal		kW	8.0	11.2	16.0	22.0	25.0
		COP			4.40	4.46	4.10	4.20	4.00
	A2W35*2	Nominal		kW	7.5	10.0	12.0	16.0	20.0
		COP			3.40	3.32	3.24	3.11	2.80
Average climate water outlet 35°C*3		Class			A++	A++	A++	A++	
		ηs			162/160	167/165	162/162	161	163
Average climate water outlet 55°C*3		Class			A++	A++	A++	A++	
		ηs			129/128	130/129	125/125	125	127
DHW 200(L)/300(L) Load Profile (Average climate)*4		Class			A+ / A	A+ / A	-	-	
		ηwh			145/120	145/120	138/118	-	-
Max outlet water temperature (°C)					60	60	60	-	-
Cooling	A35W7*2	Nominal		kW	7.1	10.0	12.5	16.0	20.0
		EER			2.70	2.83	2.32	2.76	2.25
	A35W18*2	Nominal		kW	7.1	10.0	14.0	18.0	22.0
		EER			4.43	4.47	4.08	4.56	4.1
PWL (Heating)*5				dB(A)	58	60	72	78	78
Max operating current				A	22.0/11.5	28.0/12.0	29.5/13.0	19.0	21.0
Breaker size				A	25/16	32/16	32/16	25	32
Piping	Diameter	Liquid/Gas	mm	9.52/15.88	9.52/15.88	9.52/15.88	9.52/25.4	12.7/25.4	
	Length	Out-In	m	40	75	75	80	80	
	Height	Out-In	m	10	10	30	30	30	
Guaranteed Operating Range	Heating		°C	-20°C~21°C	-20°C~21°C	-20°C~21°C	-20°C~21°C	-20°C~21°C	
	DHW		°C	-20°C~35°C	-20°C~35°C	-20°C~35°C	-20°C~35°C	-20°C~35°C	
	Cooling		°C	-15°C~46°C	-15°C~46°C	-15°C~46°C	-15°C~46°C	-15°C~46°C	

Model name				ZUBADAN				
				PUHZ-SHW80V/YAA(-BS)	PUHZ-SHW112V/YAA	PUHZ-SHW140YHA	PUHZ-SHW230YKA2	
Refrigerant				R410A*1				
Dimensions		HxWxD	mm	1020x1050x480	1020x1050x480	1350x950x330	1338x1050x330	
Weight		kg		116/128	116/128	134	143	
Power supply (V / Phase / Hz)				VAA, VHA: 230 / 1-ph / 50, YAA, YHA, YKA: 400 / 3-ph / 50				
Heating	A7W35*2	Nominal		kW	8.0	11.2	14.0	23.0
		COP			4.65	4.40	4.22	3.65
	A2W35*2	Nominal		kW	8.0	11.2	14.0	23.0
		COP			3.55	3.22	2.96	2.37
Average climate water outlet 35°C*3		Class			A++	A++	A++	
		ηs			169/167	171/169	163	164
Average climate water outlet 55°C*3		Class			A++	A++	A++	
		ηs			133/132	135/135	127	127
DHW 200(L)/300(L) Load Profile (Average climate)*4		Class			A+ / A	A+ / A	-	-
		ηwh			145/120	145/120	138/118	-
Max outlet water temperature (°C)				60	60	60	60	
Cooling	A35W7*2	Nominal		kW	7.1	10.0	12.5	20.0
		EER			3.31	2.83	2.17	2.22
	A35W18*2	Nominal		kW	7.1	10	12.5	20.0
		EER			4.52	4.74	4.26	3.55
PWL (Heating)*5				dB(A)	59	60	70	75
Max operating current				A	22/13	28/13	13	20
Breaker size				A	25/16	32/16	16	25
Piping	Diameter	Liquid/Gas	mm	9.52/15.88	9.52/15.88	9.52/15.88	12.7/25.4	
	Length	Out-In	m	75	75	75	80	
	Height	Out-In	m	30	30	30	30	
Guaranteed Operating Range	Heating		°C	-28°C~21°C	-28°C~21°C	-28°C~21°C	-25°C~21°C	
	DHW		°C	-28°C~35°C	-28°C~35°C	-28°C~35°C	-25°C~35°C	
	Cooling		°C	-15°C~46°C	-15°C~46°C	-15°C~46°C	-15°C~46°C	

*1 Refrigerant leakage contribute to climate change. Refrigerant with lower global warming potential (GWP) would contribute less to global warming than a refrigerant with higher GWP, if leaked to the atmosphere. This appliance contains a refrigerant fluid with a GWP equal to 550. This means that if 1 kg of this refrigerant fluid would be leaked to the atmosphere, the impact on global warming would be 550 times higher than 1 kg of CO₂, over a period of 100 years. Never try to interfere with the refrigerant circuit yourself or disassemble the product yourself and always ask a professional. The GWP of R410A is 2088 in the IPCC 4th Assessment Report.

*2 Air-to-Water values are measured based on EN14511 (Circulation pump input is not included.).

*3 ηs values are measured based on EN14825. *4 ηwh values are measured based on EN16147. *5 Sound power levels are measured based on EN12102.

R410A	Split type	Medium capacity (7.5kW~14kW)	Large capacity (≥16kW)
		 PUHZ-SHW80/112AA	 PUHZ-SHW140
		 PUHZ-SHW230	 PUHZ-SW75/100AA
			 PUHZ-SW160/200

Packaged Type Specifications

<Cylinder unit (Reversible)>

Model name		ERPT17X-VM2D	ERPT20X-VM2D	ERPT30X-VM2ED		
Type		Heating and cooling				
Immersion heater		-	-	-		
Expansion vessel		✓	✓	-		
Booster heater		✓	✓	✓		
Dimensions	HxWxD	mm	1400x595x680	1600x595x680	2050x595x680	
Weight (empty)		kg	86	94	107	
Control board power supply (Phase / V / Hz)			~N, 230V, 50Hz			
Heater	Booster heater	Power supply (Phase / V / Hz)	~N, 230V, 50Hz	~N, 230V, 50Hz		
		Capacity	kW	2	2	2
		Current	A	9	9	9
		Breaker size	A	16	16	16
	Immersion heater*2	Power supply (Phase / V / Hz)	-	-	-	
		Capacity	kW	-	-	-
		Current	A	-	-	-
		Breaker size	A	-	-	-
Domestic hot water tank	Volume / Material	L / -	170 / Stainless steel	200 / Stainless steel	300 / Stainless steel	
Guaranteed operating range*1	Ambient	°C	0 - 35 (≤80%RH)			
	Outdoor	Heating	°C	See outdoor unit spec table		
		Cooling	°C	See outdoor unit spec table*4		
Target temperature range	Heating	Room temperature	°C	10-30		
		Flow temperature	°C	20-60		
	Cooling	Room temperature	°C	-		
		Flow temperature	°C	5-25		
DHW tank performance	Max. hot water temperature	°C	70			
	Water heater energy efficiency class		A+		A	
Sound pressure level (PWL)		dB (A)	40			

*1 The indoor environment must be frost-free.

*2 Do not fit immersion heaters without thermal cut-out. Use only Mitsubishi Electric service parts as a direct replacement.

*3 For the model without booster heater and immersion heater, the maximum allowable hot water temperature is 3°C lower than maximum outlet water of outdoor unit.

For the maximum outlet water of outdoor unit, refer to outdoor unit data book.

*4 During cooling operation at low outdoor temperature (10°C or lower), frozen water may cause damage on plate heat exchanger.



R32

Packaged Type Specifications

<Hydro box (Reversible)>

NEW

Model name		ERPX-VM2D	
Type		Heating and cooling	
Immersion heater		-	
Expansion vessel		✓	
Booster heater		✓	
Dimensions	HxWxD	mm 800x530x360	
Weight (empty)	kg	33	
Control board power supply (Phase / V / Hz)		~N, 230V, 50Hz	
Heater	Booster heater	Power supply (Phase / V / Hz)	
		~N, 230V, 50Hz	
		Capacity	kW 2
		Current	A 9
		Breaker size	A 16
Guaranteed operating range*1	Ambient	°C 0-35 (≤80%RH)	
	Outdoor	Heating	°C See outdoor unit spec table
		Cooling	°C See outdoor unit spec table *2
Target temperature range	Heating	Room temperature	°C 10-30
		Flow temperature	°C 20-60
	Cooling	Room temperature	°C -
		Flow temperature	°C -
Sound pressure level (PWL)	dB (A)	40	

*1 The indoor environment must be frost-free.

*2 If you use our system in cooling mode at the low ambient temperature (10°C or below), there are some risks of plate heat exchanger breaking by frozen water.

R32

Packaged type

Small capacity (Under 5kW)*

Medium capacity (6.0kW-14kW)*



PUZ-HWM140

*Rated capacity is at conditions A2W35. (according to EN14511)

Packaged type

Small capacity (Under 5kW)*

Medium capacity (8.0kW-11.2kW)*



PUZ-WM50



PUHZ-WM85/112

*Rated capacity is at conditions A2W35. (according to EN14511)

Outdoor unit

NEW

Model name		PUZ-WM50VHA		PUZ-WM85V/YAA		PUZ-WM112V/YAA		PUZ-HWM140V/YHA	
Refrigerant		R32*1							
Dimensions		HxWxD	mm 943x950x330	1020x1050x480	1020x1050x480	1350x1020x330			
Weight		kg	71	98/111	119/132	132/143			
Power supply (V / Phase / Hz)		VHA • VAA: 230 / 1-ph / 50, YHA • YAA: 400 / 3-ph / 50							
Heating	A7W35*2	Nominal	kW 5.0	8.5	11.2	14.0			
		COP	5.00	4.80	4.70	4.46			
	A2W35*2	Nominal	kW 5.0	8.5	11.2	14.0			
		COP	3.70	3.51	3.44	3.15			
Average climate water outlet 35°C*3	Class	A+++		A+++	A+++	A+++			
		ηs	183	193/190	191/189	176/175			
Average climate water outlet 55°C*3	Class	A++		A++	A++	A++			
		ηs	129	139/138	134/133	132/131			
DHW 200(L) Load Profile (Average climate)*4	Class	A+		A+	A+	A+			
		ηwh	135	145	148	130			
Max outlet water temperature (°C)		60		60	60	60			
Cooling	A35W7*2	Nominal	kW 4.5	7.5	10.0	11.9			
		EER	3.40	3.15	3.30	3.00			
	A35W18*2	Nominal	kW 4.5	7.5	10.0	11.1			
		EER	5.00	4.90	4.90	4.10			
PWL (Heating)*5		dB(A)	61	58	60	67			
Max operating current		A	13.0	22.0/11.5	28.0/13.0	35.0/13.0			
Breaker size		A	16	25/16	32/16	40/16			
Piping	Diameter	Liquid/Gas	mm -	-	-	-			
	Length	Out-In	m -	-	-	-			
	Height	Out-In	m -	-	-	-			
Guaranteed Operating Range	Heating	°C	-20°C~21°C	-20°C~21°C	-25°C~21°C	-28°C~21°C			
	DHW	°C	-20°C~35°C	-20°C~35°C	-25°C~35°C	-28°C~35°C			
	Cooling	°C	10°C~46°C	10°C~46°C	10°C~46°C	10°C~46°C			

*1 Refrigerant leakage contribute to climate change. Refrigerant with lower global warming potential (GWP) would contribute less to global warming than a refrigerant with higher GWP, if leaked to the atmosphere. This appliance contains a refrigerant fluid with a GWP equal to 550. This means that if 1 kg of this refrigerant fluid would be leaked to the atmosphere, the impact on global warming would be 550 times higher than 1 kg of CO₂, over a period of 100 years. Never try to interfere with the refrigerant circuit yourself or disassemble the product yourself and always ask a professional. The GWP of R32 is 675 in the IPCC 4th Assessment Report.

*2 Air-to-Water values are measured based on EN14511 (Circulation pump input is not included).

*3 ηs values are measured based on EN14825.

*4 ηwh values are measured based on EN16147.

*5 Sound power levels are measured based on EN12102.

Optional Parts

Split type

<Indoor unit>

Parts name	Model name	Cylinder	Hydrobox	Remarks
Wireless remote controller	PAR-WT50R-E	✓	✓	
Wireless receiver	PAR-WR51R-E	✓	✓	
Thermistors	PAC-SE41TS-E	✓	✓	For room temp.
	PAC-TH011-E	✓	✓	For buffer and zone (flow and return temp.)
	PAC-TH011TK2-E	-	✓	For tank temp. (5m)
	PAC-TH012HT-E	✓	✓	For boiler and buffer (5m)
Immersion heater	PAC-IH01V2-E	✓	-	1Ph 1kW
	PAC-IH03V2-E	✓	-	1Ph 3kW
Wi-Fi interface	MAC-567IF-E	✓	✓	
2 Zone kit	PAC-TZ02-E	✓	✓	

<Outdoor unit>

Parts name	Model name	R32 (Eco Inverter)			R32 Heating only (Power Inverter)			R32 Heating only (ZUBADAN)			
		SUZ-SWM40VA	SUZ-SWM60VA	SUZ-SWM80VA	PUD-SWM80VYAA	PUD-SWM100VYAA	PUD-SWM120VYAA	PUD-SHM80VYAA	PUD-SHM100VYAA	PUD-SHM120VYAA	PUD-SHM140VYAA
Connector for drain hose heater signal output	PAC-SE60RA-E	-	-	-	✓	✓	✓	✓	✓	✓	✓
Air discharge guide	MAC-886SG-E	✓	✓	✓	-	-	-	-	-	-	-
	PAC-SG59SG-E	-	-	-	-	-	-	-	-	-	-
	PAC-SH96SG-E*1	-	-	-	✓*1	✓*1	✓*1	✓*1	✓*1	✓*1	✓*1
Air protection guide	PAC-SH63AG-E	-	-	-	-	-	-	-	-	-	-
	PAC-SH95AG-E*1	-	-	-	✓*1	✓*1	✓*1	✓*1	✓*1	✓*1	✓*1
Attachement	PAC-SJ82AT-E	-	-	-	✓	✓	✓	✓	✓	✓	✓
Drain socket*2	PAC-SG61DS-E	-	-	-	✓	✓	✓	✓	✓	✓	✓
Centralized drain pan*2	PAC-SG64DP-E	-	-	-	-	-	-	-	-	-	-
	PAC-SH97DP-E	-	-	-	-	-	-	-	-	-	-
	PAC-SJ83DP-E	-	-	-	✓	✓	✓	✓	✓	✓	✓
Base heater	MAC-642BH-U1	✓	✓	✓	-	-	-	-	-	-	-
Control/Service tool	PAC-SK52ST	-	-	-	✓	✓	✓	✓	✓	✓	✓

*1 Attachment (PAC-SJ82AT-E) is necessary for the Air guide

*2 Cannot be used for cold climate.

Parts name	Model name	R410A (Power Inverter)					R410A (ZUBADAN)			
		PUHZ-SW75VYAA	PUHZ-SW100VYAA	PUHZ-SW120VYAA	PUHZ-SW160VYAA	PUHZ-SW200VYAA	PUHZ-SHW80VYAA	PUHZ-SHW112VYAA	PUHZ-SHW140VYAA	PUHZ-SHW230VYAA
Connector for drain hose heater signal output	PAC-SE60RA-E	✓	✓	✓	✓	✓	✓	✓	✓	✓
Air discharge guide	MAC-886SG-E	-	-	-	-	-	-	-	-	-
	PAC-SG59SG-E	-	-	✓	-	-	-	-	✓	-
	PAC-SH96SG-E	✓	✓	✓	✓	✓	✓	✓	-	✓
Air protection guide	PAC-SH63AG-E	-	-	✓	-	-	-	-	✓	-
	PAC-SH95AG-E	✓	✓	-	✓	✓	✓	✓	-	✓
Attachement	PAC-SJ82AT-E	✓	✓	-	-	-	✓	✓	-	✓
Drain socket*2	PAC-SG61DS-E	✓	✓	✓	✓	✓	✓	✓	-	✓
Centralized drain pan*2	PAC-SG64DP-E	-	-	✓	-	-	-	-	-	-
	PAC-SH97DP-E	-	-	-	✓	✓	-	-	-	-
	PAC-SJ83DP-E	✓	✓	-	-	-	✓	✓	-	✓
Base heater	MAC-642BH-U1	-	-	-	-	-	-	-	-	-
Control/Service tool	PAC-SK52ST	✓	✓	✓	✓	✓	✓	✓	✓	✓

*1 Attachment (PAC-SJ82AT-E) is necessary for the Air guide

*2 Cannot be used for cold climate.

Interface/Flow Temperature Controller

Split type

Parts name	Model name	Description
Capacity step control interface	PAC-IF011B-E	1 PC board w/ Case
Flow temperature controller	PAC-IF032B-E	1 PC board w/ Case
	PAC-IF033B-E	1 PC board w/ Case
	PAC-IF033PCB-E	10 PC board w/o case
System Controllers	PAC-IF071B-E	1 PC board w/ Case
Pressure sensor	PAC-PS01-E	For SUZ-SWM40/60/80VA
Flow sensor	PAC-FS01-E	
Thermistor	PAC-TH011-E	

Optional Parts

Packaged type

<Indoor unit>

Parts name	Model name	Cylinder	Hydrobox	Remarks
Wireless remote controller	PAR-WT50R-E	✓	✓	
Wireless receiver	PAR-WR51R-E	✓	✓	
Thermistors	PAC-SE41TS-E	✓	✓	For room temp.
	PAC-TH011-E	✓	✓	For buffer and zone (flow and return temp.)
	PAC-TH011TK2-E	-	✓	For tank temp. (5m)
	PAC-TH012HT-E	✓	✓	For boiler and buffer (5m)
Immersion heater	PAC-IH01V2-E	✓ (Except EHPT20X-MHEDW)	-	1Ph 1kW
	PAC-IH03V2-E	✓ (Except EHPT20X-MHEDW)	-	1Ph 3kW
Wi-Fi interface	MAC-5671F-E	✓	✓	
2 Zone kit	PAC-TZ02-E	✓	✓	

<Outdoor unit>

Parts name	Model name	R32 (Power Inverter)			
		PUZ-WM50VHA	PUZ-WM85V/YAA	PUZ-WM112V/YAA	PUZ-HWM140V/YHA
Connector for drain hose heater signal output	PAC-SE60RA-E	✓	✓	✓	✓
Air discharge guide	PAC-SG59SG-E	✓	-	-	✓
	PAC-SH96SG-E	-	✓*	✓*	-
Air protection guide	PAC-SH63AG-E	✓	-	-	✓
	PAC-SH95AG-E	-	✓*	✓*	-
Attachement	PAC-SJ82AT-E	-	✓	✓	-
Drain socket	PAC-SG61DS-E	✓	✓	✓	-
Centralized drain pan	PAC-SG64DP-E	✓	-	-	-
	PAC-SJ83DP-E	-	✓	✓	-

*Attachment (PAC-SJ82AT-E) is necessary for the Air Guide.

Interface/Flow Temperature Controller

Packaged type

Parts name	Model name	Description
Flow temperature controller	PAC-IF033B-E	1 PC board w/ Case
	PAC-IF033PCB-E	10 PC board w/o case
System Controllers	PAC-IF072B-E	
Flow sensor	PAC-FS01-E	
Thermistor	PAC-TH011-E	



D Generation

Combination Table

Split Indoor/outdoor unit

Split indoor/outdoor unit combination		R32								R410A						ATA/ATW Hybrid system								
		Power inverter				ZUBADAN				Power inverter			ZUBADAN			Mr. SLIM+	PUMY							
		SUZ-SWM40V/A	SUZ-SWM60V/A	SUZ-SWM80V/A	PUD-SWM160V/YAA	PUD-SWM100V/YAA	PUD-SWM120V/YAA	PUD-SHWM80V/YAA	PUD-SHWM100V/YAA	PUD-SHWM120V/YAA	PUD-SHWM140V/YAA	PUHZ-SW75V/YAA	PUHZ-SW100V/YAA	PUHZ-SW120V/YHA	PUHZ-SW160YKA	PUHZ-SW200YKA	PUHZ-SHW80V/YAA	PUHZ-SHW12V/YAA	PUHZ-SHW140YHA	PUHZ-SHW230YKA2	PUHZ-FRP71VHA2	PUMY-P12V/YK/M/E/4	PUMY-P125V/YK/M/E/4	PUMY-P140V/YK/M/E/4
Heating only Cylinder	EHST17D-VM2D	●	●	●	●	●	●	●	●	●														
	EHST20D-VM2D	●	●	●	●	●	●	●	●	●														
	EHST20D-YM9D	●	●	●	●	●	●	●	●	●														
	EHST30D-YM9ED	●	●	●	●	●	●	●	●	●														
	EHST20C-VM2D										●	●				●	●	●		●	●	●	●	
	EHST20C-VM6D										●	●				●	●	●		●	●	●	●	
	EHST20C-YM9D										●	●				●	●	●		●	●	●	●	
EHST30C-VM6ED										●	●				●	●	●		●	●	●	●		
Reversible Cylinder	ERST17D-VM2D	●	●	●	●		●			●														
	ERST20D-VM2D	●	●	●	●	●	●	●	●	●														
	ERST30D-VM2ED	●	●	●	●	●	●	●	●	●														
	ERST20C-VM2D										●	●				●	●	●		●	●	●	●	
	ERST30C-VM2ED										●	●				●	●	●		●	●	●	●	
Heating only Hydro box	EHSD-VM2D	●	●	●	●	●	●	●	●	●														
	EHSD-YM9D	●	●	●	●	●	●	●	●	●														
	EHSC-VM2D										●	●				●	●	●		●	●	●	●	
	EHSC-VM6D										●	●				●	●	●		●	●	●	●	
	EHSC-YM9D										●	●				●	●	●		●	●	●	●	
EHSE-YM9ED												●	●					●						
Reversible Hydro box	ERSD-VM2D	●	●	●	●	●	●	●	●	●														
	ERSC-VM2D										●	●				●	●	●						
	ERSE-MED											●	●					●						
	ERSE-YM9ED											●	●					●						

Packaged indoor/outdoor unit

Packaged indoor/outdoor unit combination		R32			
		Power inverter	ZUBADAN		
Reversible Cylinder	ERPT17X-VM2D	●	●	●	●
		ERPT20X-VM2D	●	●	●
Reversible Hydro box	ERPX-VM2D	●	●	●	●
			ERPT30X-VM2ED	●	●

MELCloud (Wi-Fi Interface) for ecodan

MELCloud for Fast, Easy Remote Control and Monitoring of Your ecodan

MELCloud is a new Cloud-based solution for controlling ecodan either locally or remotely by computer, tablet or smartphone via the Internet. Setting up and remotely operating your ecodan heating system via MELCloud is simple and straight forward. All you need is wireless computer connectivity in your home or the building where the ecodan is installed and an Internet connection on your mobile or fixed terminal. To set up the system, the router and the ecodan WiFi interface must be paired, and this is done simply and quickly using the WPS button found on all mainstream routers.

You can control and check ecodan via MELCloud from virtually anywhere an Internet connection is available. That means, thanks to MELCloud, you can use ecodan much more easily and conveniently.



1 MELCloud uses the MAC-5671F-E interface

Key Control and Monitoring Features

- 1 Turn system on/off
- 2 See status of each of your heating zones & adjust set points
- 3 See the status of your hot water cylinder & boost remotely
- 4 Live weather feed from ecodan location
 - Holiday mode - Set system parameters while away
 - Schedule timer - Set 7 day weekly schedule
 - Frost protection - Set system to run at minimum temperature
 - Error status
- 5 Check energy usage report* *Additional metering hardware is required.



All A++ or Above!!

Outdoor unit	Indoor unit	For medium-temperature application										For low-temperature application									
		Seasonal space heating energy efficiency class	Water heating energy efficiency class	Rated heat output under average climate conditions	Seasonal space heating energy efficiency under average climate conditions	Water heating energy efficiency under average climate conditions	Rated heat output under warmer climate condition	Seasonal space heating energy efficiency under warmer climate condition	Warmer heating energy efficiency under warmer climate conditions	Sound power level LWA indoor	Sound power level LWA outdoor	Seasonal space heating energy efficiency class	Water heating energy efficiency class	Rated heat output under average climate conditions	Seasonal space heating energy efficiency under average climate conditions	Water heating energy efficiency under average climate conditions	Rated heat output under warmer climate condition	Seasonal space heating energy efficiency under warmer climate condition	Warmer heating energy efficiency under warmer climate conditions	Sound power level LWA indoor	Sound power level LWA outdoor
				kW	%	%	kW	%	%	dB	dB			kW	%	%	kW	%	%	dB	dB
SUZ-SWM40VA	EHST17D-***D	A++	A+	4.6	129	148	4.6	155	167	41	58	A+++	A+	5.1	180	148	5.1	216	167	41	58
	ERST17D-***D	A++	A+	4.6	132	148	4.6	160	167	41	58	A+++	A+	5.1	187	148	5.1	225	167	41	58
	EHST20D-***D	A++	A+	4.6	129	159	4.6	155	173	41	58	A+++	A+	5.1	180	159	5.1	216	173	41	58
	ERST20D-***D	A++	A+	4.6	132	159	4.6	160	173	41	58	A+++	A+	5.1	187	159	5.1	225	173	41	58
	EHST30D-***D	A++	A+	4.6	129	128	4.6	155	149	41	58	A+++	A+	5.1	180	128	5.1	216	149	41	58
	ERST30D-***D	A++	A+	4.6	132	128	4.6	160	149	41	58	A+++	A+	5.1	187	128	5.1	225	149	41	58
	EHSD-***D	A++	-	4.6	129	-	4.6	155	-	41	58	A+++	-	5.1	180	-	5.1	216	-	41	58
	ERSD-***D	A++	-	4.6	132	-	4.6	160	-	41	58	A+++	-	5.1	187	-	5.1	225	-	41	58
SUZ-SWM60VA	EHST17D-***D	A++	A+	6.0	130	144	6.0	138	167	41	60	A+++	A+	6.6	181	144	6.6	192	167	41	60
	ERST17D-***D	A++	A+	6.0	133	144	6.0	142	167	41	60	A+++	A+	6.6	187	144	6.6	198	167	41	60
	EHST20D-***D	A++	A+	6.0	130	148	6.0	138	173	41	60	A+++	A+	6.6	181	148	6.6	192	173	41	60
	ERST20D-***D	A++	A+	6.0	133	148	6.0	142	173	41	60	A+++	A+	6.6	187	148	6.6	198	173	41	60
	EHST30D-***D	A++	A+	6.0	130	128	6.0	138	164	41	60	A+++	A+	6.6	181	128	6.6	192	164	41	60
	ERST30D-***D	A++	A+	6.0	133	128	6.0	142	164	41	60	A+++	A+	6.6	187	128	6.6	198	164	41	60
	EHSD-***D	A++	-	6.0	130	-	6.0	138	-	41	60	A+++	-	6.6	181	-	6.6	192	-	41	60
	ERSD-***D	A++	-	6.0	133	-	6.0	142	-	41	60	A+++	-	6.6	187	-	6.6	198	-	41	60
SUZ-SWM80VA	EHST17D-***D	A++	A+	7.1	131	144	7.1	135	167	41	62	A+++	A+	7.1	182	144	7.1	186	167	41	62
	ERST17D-***D	A++	A+	7.1	133	144	7.1	138	167	41	62	A+++	A+	7.1	187	144	7.1	191	167	41	62
	EHST20D-***D	A++	A+	7.1	131	148	7.1	135	173	41	62	A+++	A+	7.1	182	148	7.1	186	173	41	62
	ERST20D-***D	A++	A+	7.1	133	148	7.1	138	173	41	62	A+++	A+	7.1	187	148	7.1	191	173	41	62
	EHST30D-***D	A++	A+	7.1	131	128	7.1	135	164	41	62	A+++	A+	7.1	182	128	7.1	186	164	41	62
	ERST30D-***D	A++	A+	7.1	133	128	7.1	138	164	41	62	A+++	A+	7.1	187	128	7.1	191	164	41	62
	EHSD-***D	A++	-	7.1	131	-	7.1	135	-	41	62	A+++	-	7.1	182	-	7.1	186	-	41	62
	ERSD-***D	A++	-	7.1	133	-	7.1	138	-	41	62	A+++	-	7.1	187	-	7.1	191	-	41	62
PUD-SWM80V/YAA(-BS)	E*ST17D-***D	A++	A+	8.0	131/130	136	8.0	161/159	154	41	56	A+++	A+	8.0	178/176	136	8.0	218/215	154	41	56
	E*ST20D-***D	A++	A+	8.0	131/130	148	8.0	161/159	162	41	56	A+++	A+	8.0	178/176	148	8.0	218/215	162	41	56
	E*ST30D-***D	A++	A	8.0	131/130	121	8.0	161/159	145	41	56	A+++	A	8.0	178/176	121	8.0	218/215	145	41	56
	E*SD-***D	A++	-	8.0	131/130	-	8.0	161/159	-	41	56	A+++	-	8.0	178/176	-	8.0	218/215	-	41	56
PUD-SWM100V/YAA(-BS)	E*ST20D-***D	A++	A+	10.0	131/130	148	10.0	152/151	162	41	59	A+++	A+	10.0	178/177	148	10.0	221/218	162	41	59
	E*ST30D-***D	A++	A	10.0	131/130	121	10.0	152/151	145	41	59	A+++	A	10.0	178/177	121	10.0	221/218	145	41	59
	E*SD-***D	A++	-	10.0	131/130	-	10.0	152/151	-	41	59	A+++	-	10.0	178/177	-	10.0	221/218	-	41	59
PUD-SWM120V/YAA(-BS)	E*ST20D-***D	A++	A+	12.0	129/128	148	12.0	150/149	162	41	60	A+++	A+	12.0	177/176	148	12.0	217/215	162	41	60
	E*ST30D-***D	A++	A	12.0	129/128	121	12.0	150/149	145	41	60	A+++	A	12.0	177/176	121	12.0	217/215	145	41	60
	E*SD-***D	A++	-	12.0	129/128	-	12.0	150/149	-	41	60	A+++	-	12.0	177/176	-	12.0	217/215	-	41	60
PUD-SHWM80V/YAA(-BS)	E*ST17D-***D	A++	A+	8.0	135/134	136	8.0	166/164	154	41	56	A+++	A+	8.0	181/179	136	8.0	225/222	154	41	56
	E*ST20D-***D	A++	A+	8.0	135/134	148	8.0	166/164	162	41	56	A+++	A+	8.0	181/179	148	8.0	225/222	162	41	56
	E*ST30D-***D	A++	A	8.0	135/134	121	8.0	166/164	145	41	56	A+++	A	8.0	181/179	121	8.0	225/222	145	41	56
	E*SD-***D	A++	-	8.0	135/134	-	8.0	166/164	-	41	56	A+++	-	8.0	181/179	-	8.0	225/222	-	41	56

Note: E**T17/20*-***D use "Load profile L"
 E**T30*-***D use "Load profile XL"



Refrigerant Amount

M/S/P/Multi/Zubadan/ATW

	Model Name	Refrigerant		Pre-charged quantity		Max. added quantity		
			GWP	Weight (kg)	CO ₂ equivalent [t]	Weight (kg)	CO ₂ equivalent [t]	
PUMY	PUMY-SP112VKM(-BS)	R40A	2088	3.5	7.31	9.0	18.79	
	PUMY-SP112YKM(-BS)	R410A	2088	3.5	7.31	9.0	18.79	
	PUMY-SP125VKM(-BS)	R410A	2088	3.5	7.31	9.0	18.79	
	PUMY-SP125YKM(-BS)	R410A	2088	3.5	7.31	9.0	18.79	
	PUMY-SP140VKM(-BS)	R410A	2088	3.5	7.31	9.0	18.79	
	PUMY-P112VKM5(-BS)	R410A	2088	4.8	10.02	13.8	28.81	
	PUMY-P125VKM5(-BS)	R410A	2088	4.8	10.02	13.8	28.81	
	PUMY-P140VKM5(-BS)	R410A	2088	4.8	10.02	13.8	28.81	
	PUMY-P112YKM(E)4(-BS)	R410A	2088	4.8	10.02	13.8	28.81	
	PUMY-P125YKM(E)4(-BS)	R410A	2088	4.8	10.02	13.8	28.81	
	PUMY-P140YKM(E)4(-BS)	R410A	2088	4.8	10.02	13.8	28.81	
	ATW Packaged	PUZ-WM50VHA	R32	675	2.0	1.35	-	-
PUZ-WM85V/YAA		R32	675	2.2	1.49	-	-	
PUZ-WM112V/YAA		R32	675	3.0	2.03	-	-	
PUZ-HWM140V/YHA		R32	675	3.3	2.2275	-	-	
ATW Split	SUZ-SWM40VA	R32	675	1.2	0.81	0.4	0.27	
	SUZ-SWM60VA	R32	675	1.2	0.81	0.4	0.27	
	SUZ-SWM80VA	R32	675	1.2	0.81	0.4	0.27	
	PUD-SWM80V/YAA	R32	675	1.3	0.8775	0.3	0.20	
	PUD-SWM100V/YAA	R32	675	1.6	1.08	0.23	0.16	
	PUD-SWM120V/YAA	R32	675	1.6	1.08	0.23	0.16	
	PUD-SHWM80V/YAA	R32	675	1.4	0.945	0.3	0.20	
	PUD-SHWM100V/YAA	R32	675	1.7	1.1475	0.13	0.09	
	PUD-SHWM120V/YAA	R32	675	1.7	1.1475	0.13	0.09	
	PUD-SHWM140V/YAA	R32	675	1.7	1.1475	0.13	0.09	
	PUHZ-SW75V/YAA	R410A	2088	3.0	6.27	1.8	3.76	
	PUHZ-SW100V/YAA	R410A	2088	4.2	8.77	1.6	3.76	
	PUHZ-SW120V/YHA	R410A	2088	4.6	9.61	2.9	6.06	
	PUHZ-SW160YKA	R410A	2088	7.1	14.83	4.0	8.36	
	PUHZ-SW200YKA	R410A	2088	7.7	16.08	5.2	8.36	
	PUHZ-SHW80V/YAA	R410A	2088	4.6	9.61	1.4	2.93	
	PUHZ-SHW112V/YAA	R410A	2088	4.6	9.61	1.4	2.93	
	PUHZ-SHW140YHA	R410A	2088	5.5	11.49	2.4	5.02	
	PUHZ-SHW230YKA2	R410A	2088	7.1	14.83	8.4	17.54	
	Mr. Slim+	PUHZ-FRP71VHA2	R410A	2088	3.8	7.94	1.8	3.76



 **NOTICE**

- Do not install indoor units in areas (e.g. mobile phone base stations) where the emission of VOCs such as phthalate compounds and formaldehyde is known to be high as this may result in a chemical reaction.
- Our air-conditioning equipments and heat pumps contain a fluorinated greenhouse gas, R410A (GWP: 2088) or R32 (GWP: 675). *These GWP values are based on Regulation (EU) No.517/2014 from IPCC 4th edition. In case of Regulation (EU) No.626/2011 from IPCC 3rd edition, these are as follows. R410A (GWP: 1975), R32 (GWP: 550)
- When installing or relocating or servicing our air-conditioning equipment, use only the specified refrigerant (R410A or R32) to charge the refrigerant lines.
Do not mix it with any other refrigerant and do not allow air to remain in the lines.
If air is mixed with the refrigerant, then it can be the cause of abnormal high pressure in the refrigerant lines, and may result in an explosion and other hazards.
The use of any refrigerant other than that specified for the system will cause mechanical failure, system malfunction or unit breakdown. In the worst case, this could lead to a serious impediment to securing product safety.

MITSUBISHI ELECTRIC CORPORATION

HEAD OFFICE: TOKYO BUILDING, 2-7-3 MARUNOUCHI, CHIYODA-KU, TOKYO 100-8310, JAPAN
<http://Global.MitsubishiElectric.com/>

Full Product Catalogue - Heating 2022 (Air to water)
E-2203260(17360)



E-2203260